

# Final report

## 1.1 Project details

<b>Project title</b>	<b>RePlan</b> Ancillary services from renewable power plants
<b>Project identification (program abbrev. and file)</b>	PSO 2015-1-12347
<b>Name of the programme which has funded the project</b>	ForskEL
<b>Project managing company/institution (name and address)</b>	<b>DTU Wind Energy</b> Frederiksborgvej 399, Build.118 4000 Roskilde
<b>Project partners</b>	CEE DTU Elektro, AAU ET, AAU WCN Vestas Wind Systems A/S
<b>CVR</b> (central business register)	30060946
<b>Date for submission</b>	01/09/2018

## 1.2 Short description of project objective and results

In addition to contributing to the energy balance, renewable generation (ReGen) plants of the future should have similar regulating properties as conventional power plants. ReGen plants should thus play a role not only into the energy production, but also into the delivery of ancillary services which are needed to ensure the system stability comprising both transmission and distribution level.

This project has targeted development and verification of the ancillary service control features in a ReGen plant control architecture, by addressing particularly features like frequency/ active power, voltage/ reactive power support from wind power (WP) and solar photovoltaic (PV) plants. Communication between ReGen plants and system operators' control rooms, as well as the impact of the Information and Communication Technologies (ICT) infrastructure on provision and coordination of ancillary services from ReGen plants have also been investigated. The technical results have been widely communicated to relevant stakeholders.

## 1.3 Executive summary

Modern ReGen plants can provide the distribution and transmission network with useful ancillary services, such as voltage and frequency control. The RePlan project has defined ReGen plant level control algorithms, modelled and simulated their technical performance, and tested them in a Real-Time Hardware-in-the-Loop (HIL) environment based on multi-domain physical systems or in a real small scale power system, namely the SYSLAB facility existing at the DTU Risø Campus. RePlan has developed and evaluated controllers for the delivery of ancillary services, incorporating communication properties in the control loops of the ReGen plant model and using state-of-the-art methods for simulation of renewable generation patterns and wind power forecast methods. Guidelines and recommendations for practical implementation of the developed control algorithms for targeted ancillary services have been defined.

The technical ability is clear. The scientific contribution and industrial relevance is satisfactory. The continuation is straightforward, if commercial prospects prove their incentive.

## 1.4 Project objectives

#### *1.4.1 Motivation & background*

The foreseen high penetration of WP and solar PV into the Danish electricity supply imposes the requirement that the bulk addition of large scale ReGen plants to the grid will not be detrimental to the overall stability of the power system. One way of ensuring this, which has been also the RePlan project vision, is to require renewable power plants, like WP and PV plants, to have similar regulating properties as conventional power plants and to coordinate their grid support services as well.

The RePlan project concept arose based on this need, namely that WP and PV plants, should play a role not only into the energy production, as it is today, but also into the provision of ancillary services to ensure the system stability comprising both transmission and distribution level. In the future the amount of power system needs for ancillary services will increase with high share of ReGen. This fact leads to fundamental changes in the way transmission and distribution network operators (TSO and DSOs) will have to use grid support services from ReGen plants to manage the voltage and frequency stability in the future power system, which will continuously evolve through new interconnections and use large scale renewable technologies.

The need for regulating properties in WP and PV plants, similar to those existing in the conventional power plants, has been intensified the research toward ancillary services from ReGen plants in the last few years. In spite of this, for example, in the context of ancillary services delivery from WP plants, investigations on research topics like coordination of WP plants in providing reactive power and voltage control, faster and reliable communication (i.e. between wind farms and system operators control rooms), as well as dedicated tuning of the control strategies have been not very much in focus. In the context of ancillary services delivery from PVs, more efforts have been still needed to fill the knowledge gap and to develop improved methods and solutions regarding available power estimation, faster and reliable communication and control within the plants and improved control strategies.

Additionally, a thorough insight and understanding of the increasing complexity of the future power system with large share of wind and solar plants has been lowly prioritised. Furthermore, most of the research has been conducted with focus only on one particular technology, namely WP or PV, without any insight on the opportunity to coordinate system services from different renewable technologies.

The above considerations are well described in the project application [1], where the development and verification of new technical solutions for provision of ancillary services, like frequency/ active power, voltage/ reactive power support from WP and PV plants, the investigation of impact of ICT on the provision of such services and the possibility to exploit and coordinate the ancillary services from WP and PV plants, identifying and analyzing their strengths and limitations, have been identified as main targets in RePlan project.

Guidelines and recommendations for implementation of control algorithms for WP and PV ancillary services had to be defined in order to provide a deep insight for stakeholders i.e. wind turbines and PV system manufacturers, system operators regarding the existing boundaries for current technologies and requirements for accommodating the new ancillary services in industrial application.

#### *1.4.2 Problem objectives*

The overall objective of RePlan project has been to contribute to the integration of large share of renewable energy in the Danish power system and thus to enable a resilient power system in the future by developing technical solutions for the provision of ancillary services by renewable power plants. RePlan focused on WP and PV plants since they are expected to jointly produce the lion's share of renewable energy generation capacity needed to reach the Danish government 2050 targets.

The project application states that the novelty of RePlan project consists in the investigation of:

- the ancillary services provision from WP and PV plants, by developing advanced controllers, incorporating communication properties in the control loops of the ReGen plant model and using state-of-the-art methods for simulation of renewable generation patterns and wind power forecast methods.
- the suitability to coordinate their services provision to power system operator, by identifying and analyzing the strengths and limitations of WP and PV plants, anticipating new challenges and exploring some of the more complex issues and uncertainties related to the coordination of their ancillary services. The services with great concerns in the future include: voltage, frequency and rotor angular stability support.

The project application further states that RePlan project also targets to address the imperative need for verification and extensive studies of the impact of grid support services from WP and PV plants on the power system stability. In this respect, by defining guidelines and recommendations for implementation of control algorithms for WP and PV ancillary services, RePlan also aimed to provide a deep insight for stakeholders i.e. wind turbines and PV system manufacturers, system operators regarding the existing boundaries for current technologies and requirements for accommodating the new ancillary services in industrial application.

The project's problem statement and scientific method has been proceeded based on the representative steps depicted in Figure 1, namely starting with an hypothesis, different cases has been identified as relevant tests for simulation and & evaluation of the usefulness of WP and PV plant provided ancillary services.

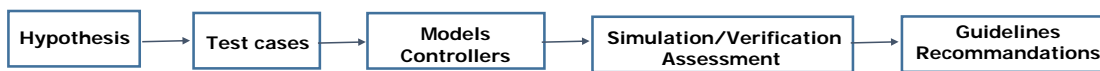

Figure 1: Scientific method

Representative simulation models for WP and PV plants and their control have been then identified and further developed to assess their behaviour and the suitability to coordinate their support to the power system for the identified test cases. Guidelines and recommendations for implementation of control algorithms for WP and PV ancillary services have been then generated.

### 1.4.3 Project organization and implementation

The project has been organized in seven work-packages as illustrated in Figure 2, namely in 5 research work-packages, one work-package dedicated to management and one work package (WP) dedicated to dissemination activities.

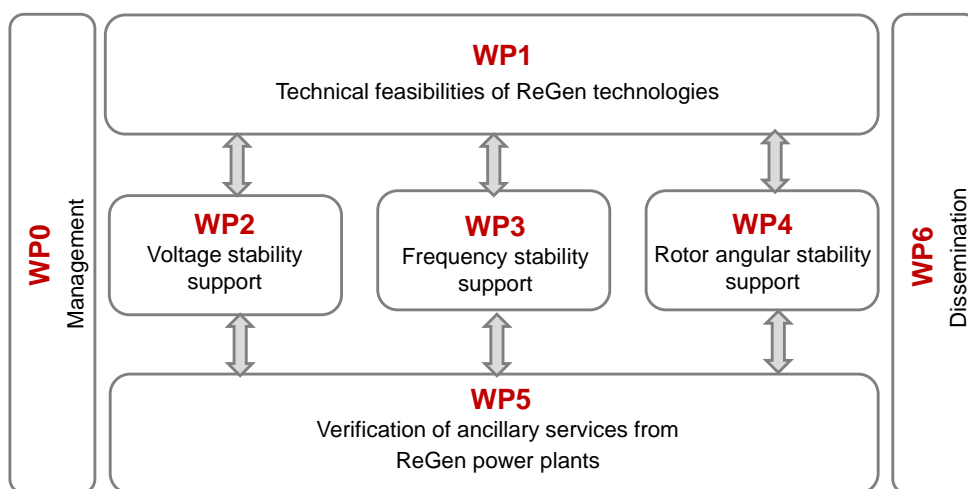

Figure 2: Overview of work-packages.

The project's objectives has required connecting research disciplines spanning wind power and photovoltaic plant models and control, control software, electric components, power system

dynamics, hardware design, software and simulation tools like real time dynamic simulator. All these expertises have been connected with an industrial perspective.

The project partners have been selected on the basis of specific skills to the project, the complementarity of their expertise, past collaboration experience and research track record. Their roles within the project have clearly delineated and chosen on the basis of the needs of the project. The combination of university research and industrial experience has been a particularly powerful feature of the consortium. The some degree of overlap between the partners' expertise has been facilitated productive communication and interactions between the partners. This overlap has been also important for risk management.

It resulted in the project organisation and work package structure depicted in Table 1.

WP - title	Budget (man-months)						Duration	
	TOTAL	DTU Wind Energy	AAU ET	CEE DTU Elektro	AAU WCN	VESTAS	start	end
WP0 - Management	2	2	0	0	0	0	2015.03	2018.02
WP1 - Technical feasibilities of ReGen technologies	15	6	2	6	1	0	2015.03	2015.12
WP2 - Voltage stability support from ReGen plants	13	6	6	1	1	0	2015.11	2016.08
WP3 - Frequency stability support from ReGen plants	14	6	2	5	1	0	2016.01	2017.04
WP4 - Rotor angular stability support from ReGen plants	9	4	4	1	1	0	2016.11	2017.09
WP5 - Verification of ancillary services from ReGen plants	27	4	7	7	3	6	2017.04	2018.02
WP6 - Dissemination	5	2	1	1	1	0	2015.03	2018.02
	84	30	22	20	6	6		

Table 1: Work packages, with budgeted hours, durations and work packages leaders.

The project budget has consisted mainly of man-hours. The total budget of the project has been **5.991 kDKK**, splitted into:

- Man-hours: 5.429 kDKK
- Travel: 200kDKK
- Others (simulation tool licenses, laboratory equipment, experiments): 195kDKK.

The partners' contribution has been **677 kDKK**. Hence, the funding applied from PSO has been **5.314 kDKK** which represented **89%** of total budget.

#### 1.4.4 Project limitations

Throughout, the project has made conscious choices of what to include and what to leave out. To complement the problem statement, a series of items have been excluded or assumed valid from previous work.

##### Choice of PV and wind turbine simulation models:

- WP plant model: simplified model of the IEC 61400-27-1 type 4B, adjusted and extended to include new features. Some particular studies e.g. voltage control co-ordination and Rotor Angle Stability support are using a simpler representation such as first order delay to capture the entire plant performance.
- Solar PV system model: developed specifically for power system studies with a frequency bandwidth of maximum 5Hz. The solar irradiation time series have thus a resolution of minimum 200msec. This model is not suitable for studies like fault ride-through, protection, voltage unbalances, and asymmetries.

##### Choice of power system models:

- MV power system model used for voltage stability studies
- HV+MV power system model used for frequency stability studies
- HV power system model used for rotor angle stability support studies
- operating limits on the conventional power plants such as the rate-of-change-of-frequency (ROCOF) and their possible violation are not considered.
- the damping influence of frequency dependent loads is neglected in part due to difficulties of estimating realistic values.
- local variations of the frequency, which are common in large power systems, are neglected on power system level. It is hence assumed that the frequency level is equal at each generator and load connection.

**Wind power generation** is modeled on WP plant level, i.e. the single turbine dynamics are not considered and the focus lies on the production of the whole WP plant.

**Plant aggregation:**

- internal grid and individual assets are neglected.
- WP plant is represented by one equivalent lumped wind turbine with rescaled power capacity. Consequently, local phenomena such as wake effects or losses in the electrical components within the WP plant are neglected as well as different inflow conditions due to obstacles or roughness differences.
- Each aggregated WP plant is operating at a constant wind speed over the simulation time. As the considered simulation time amounts to roughly one minute, the wind speed and thus the operating point of the WP plant would in reality be subject to change. However, it is assumed that the time period is short enough to not introduce significant inaccuracies to the result.
- Each aggregated PV plant is represented as an equivalent PV panel with a single point solar irradiance considered as input. Smoothing effect on power output is also considered in the model.

**Levels where ancillary services are included in RePlan project:**

- secondary voltage control, secondary frequency control are included in the aggregator level
- primary voltage control and primary frequency control (fast frequency control) are included in the ReGen plant control level.

**Coordination in RePlan project:** refers to the allocation/scheduling and configuration of functionality of assets to deliver a given ancillary service, taking into account the real time communication, the capabilities and availability of resources.

**Coordination in RePlan defined in respect to each ancillary service:**

- For voltage control, secondary frequency control: coordination refers to the allocation of resources to deliver a given service, taking into account the real time communication and the whole control levels chain.
- For fast frequency control: coordination refers to the scheduling of the assets to provide their contribution to a given service. This scheduling indicate the reserve allocation (how much from each asset), order of their activation and the different moments in time when they are activated (i.e delay their response).
- For rotor angle stability support: coordination refers to selection of measurement points in the power grid and tuning of individual control parameters according to power system characteristics

**Communication in RePlan project** is considered only in the aggregation level and not internal at the ReGen plant level.

*1.4.5 Project evolution*

The project has delivered successfully all planned deliverables – as reflected in Table 2. Two internal reports have been additionally created. The list of deliverable reports matches the list set out in the project application, and has answered the project problem statement.

Report nr.	Report title	Issuer	Date	Length
D1.1	Specifications for ReGen plant model and control architecture	DTU Wind Energy	Dec. 2015	57pp
D1.2	Technical Feasibility of Ancillary Services provided by ReGen Plants	AAU ET	Sept. 2015	36pp
D1.3	A review on Optimal dispatch methods for ReGen Plants	DTU Electro	Dec. 2015	16pp
D2	Voltage control support and coordination between ReGen plants in Distribution Systems	AAU ET	Nov. 2016	101pp
Additional report	Communication aspects in RePlan	AAU WCN	Sept. 2016	52pp
D3	Frequency stability control support from ReGen plants	DTU Wind Energy	Aug. 2017	42pp
Additional report	ICT impact on primary frequency control support and coordination from ReGen plants	AAU WCN	Feb. 2018	30pp
D4	Rotor angle stability support from ReGen plants in power systems	AAU ET	Feb. 2018	12pp
D5.1	Verification of Ancillary services in Large Scale Power System	AAU ET	Feb. 2018	36pp
D5.2	Experimental Validation of Fast Frequency Control from ReGen plants	DTU Electro	Feb. 2018	13pp

Table 2: Project deliverables and internal additional reports.

The deliverable reports are available on the project sharepoint and/or project homepage ([www.replanproject.dk](http://www.replanproject.dk)). The additional internal reports are available only on the project sharepoint.

Figure 3 and Figure 4 show the budgeted and actual man-hours per partner and per project reporting period, respectively. Table 3 shows the budgeted and actual cost for the entire project period. Figure 5 depicts the project total cost in DKK (budgeted and actual).

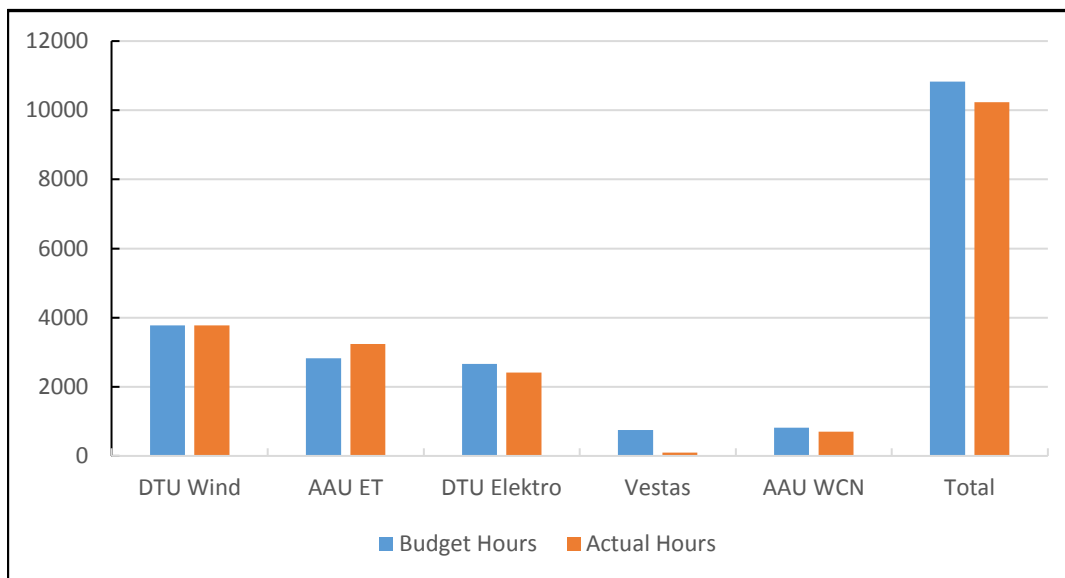

Figure 3: Project man-hours, budget and actual spend, per partner.

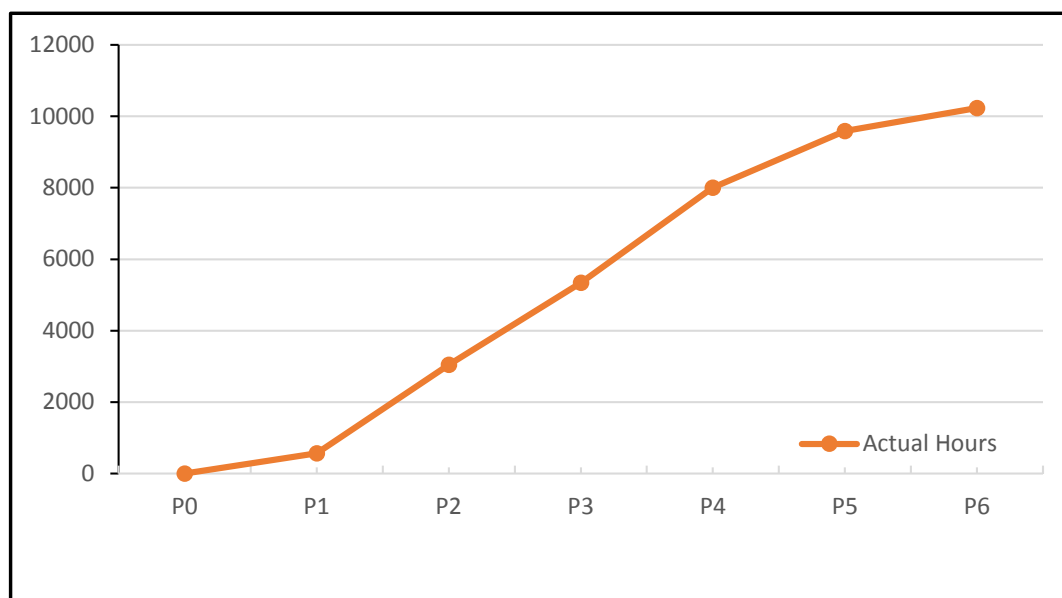

Figure 4: Project actual man-hours per partner.

Project Totals	Total cost	Internal Cost	Funding	Total hours
<b>Budget, DKK</b>	5.990.805	676.580	5.314.224	10831
<b>Actual, DKK</b>	5.292.371	548.687	4.743.684	10232
<b>Actual vs budget, %</b>	88%	81%	89%	94%
<b>Residal, DKK</b>	698.434	127.893	570.540	599

Table 3: Project budget and actual cost.

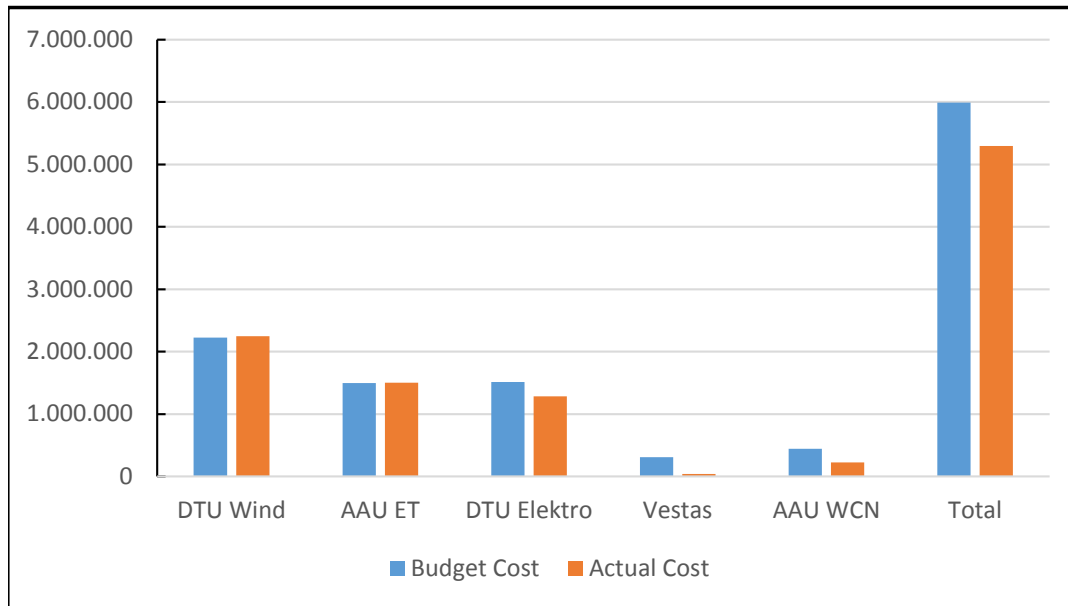

Figure 5: Project total cost, DKK (budget and actual).

The following comments are relevant at this stage:

- DTU Wind: total actual hours match the total budgeted hours.
- AAU ET: slight overspend on hours, but with some hours distributed to staff of lower hourly rates than budgeted cost while PSO share of funding were kept as planned initially.
- DTU Elektro: actual hours and cost are slightly below the budgeted hours and budget, respectively.
- AAU WCN: actual hours are almost the same as the budgeted hours. However, the actual cost is much lower than the budgeted one because the research here has been mainly done by a PhD student, whose hours have much lower rates.
- Vestas: actual hours is significant lower than the budgeted hours. Vestas has undergone a set of changes and this has challenged the continuity during the projects period, not being able to fully satisfy the commitment in terms of delivered hours. As Vestas undergone a set of staffing changes during the course of the project, certain responsibilities were redistributed several times. This has challenged the continuity in the discussions with the other project partners about the tests set up and how to conduct the lab test with an industrial perspective. Therefore, the hours spent by Vestas in the project were mainly for participating the meetings and reviewing the documents purpose. The consequence has been not optimal exploiting Vestas industrial perspective and experience embedded power plant control related to grid integration of wind, however with no sacrifice on agreed deliverables and their relevance to industry.

### 1.5 Project results and dissemination of results

RePlan focuses on three ancillary services from WP and PV plants: voltage, frequency and rotor angular stability support. These services, needed to ensure the system stability comprising both transmission and distribution level, vary in their scope and importance for the electrical grid stability. As these services correspond to different time scales, they have been addressed in the project in different parallel work-packages, alias **WP2**, **WP3** and **WP4**.

In order to have online voltage/frequency stability support from ReGen plants to ensure the system stability, these plants should have a resilient online coordination with the system operator (i.e. DSO/TSO), which however, depends on the requirements imposed on the Information and Communication Technologies (ICT) infrastructure. Latency, data rate, redundancy, serviceability, reliability, costs of deployment and ownership are factors that define the requirements and finally lead to a choice of suitable technology. A common requirement shared

by all three services is a reliable and secure communication infrastructure. The individual ancillary service therefore has to be able to deal with impairments up to a complete breakdown of parts of the ICT infrastructure. For instance, if an interface exhibits increased latency, while the data rate decreases, possibly due to network congestion, this has to be detected and acted upon.

The needs for these ancillary services from ReGen plants are quantified in RePlan through several studies, taking the size, the robustness of power system, as well as the technical characteristics and the penetration levels of the ReGen into consideration. Therefore, for each ancillary services in focus, different generic grid cases are investigated, aiming to reflect and exhibit the dynamic response and the particular phenomena on focus in a power system with large displacement of the conventional plants by ReGen plants. Possible coordination scenarios have been explored analyzing which technology (wind turbines, solar photovoltaics or their combination) is most suitable for service provision in a given scenario. The incorporation of communication properties and of power availability has been considered in the development and implementation of the controllers for the delivery of ancillary services.

The following pages summarise the results obtained in the project. The illustrations are all from the project internal reports listed in Table 2.

#### *1.5.1 Technical feasibilities of ReGen technologies (WP1)*

The objective of **WP1** was to define a generic hierarchical control framework for the renewable generation (ReGen) plants used in RePlan project as well as a coordination approach between ReGen plants, in the provision of ancillary services to support the stability of a future entire renewable energy integrated power system. This generic ReGen model and control framework including information and communication technology (ICT) has been used as a starting platform for the specific ancillary service developments and assessments addressed and developed in work-packages **WP2**, **WP3** and **WP4**.

**WP1** has focused on the specifications of the ReGen plant model and control architecture used in RePlan project, control functions, control architecture (levels, concepts, coordination) as well as on the model for aggregated WP plants, PV plants and the power system, including communication properties. Examples and guidelines for possible coordination between ReGen plants in the provision of each ancillary services have been discussed aiming to be used in the following work-packages of the RePlan project.

Figure 6 defines the general system architecture relevant for RePlan, including the power system structure and its assets, the communication layer and the involved actors having roles and responsibilities for ancillary services (ICT actors, market players, technical performance palyers). All plants and the actors being involved in the provision of ancillary services are cross-linked through the communication network [2], [3].



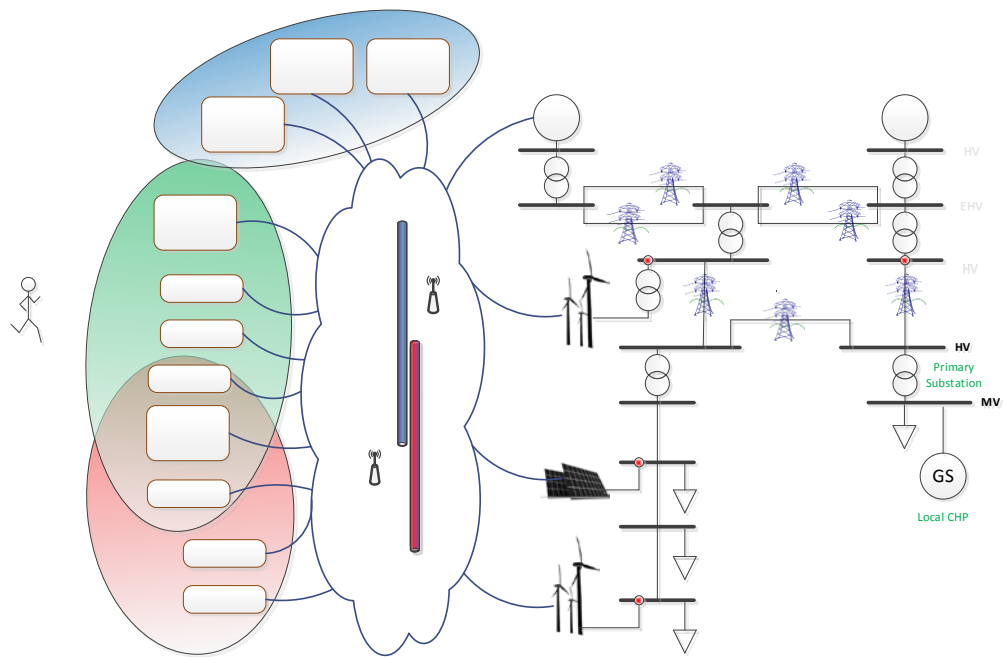

Figure 6: General system architecture including power system & assets, control levels, ICT layer and actors

Figure 7 depicts the general control architecture used in RePlan project including power system & assets and the following control levels, depicted both for transmission and distribution systems, respectively:

- L2: Control Centre (TSO/DSO)
- L1: Aggregator Control
- L0: Plant Control

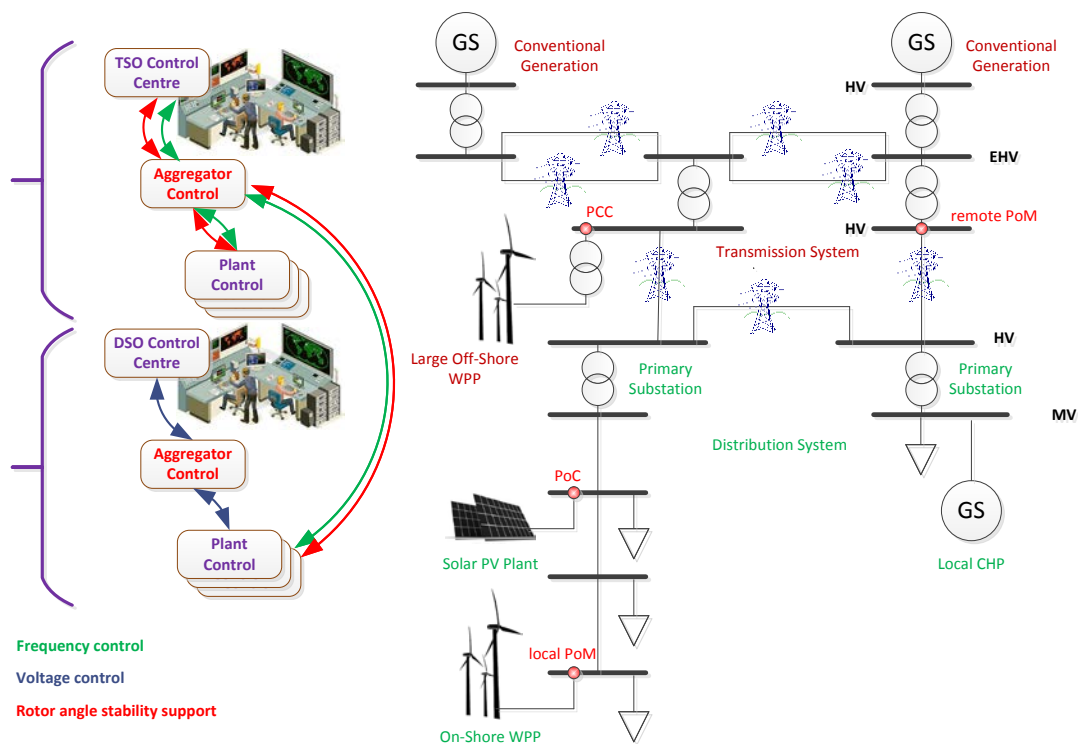

Figure 7: General control architecture including power system & assets and control levels

The control architecture is described in terms of control levels, control concepts and control coordination. The ancillary services addressed as specific control functions in RePlan, i.e. frequency control, voltage control and rotor angle stability support, are indicated by different colors (i.e. green / blue / red) and addressed at their respective control levels.

The possible realization of control functions in the various control levels are summarized in the following table as well as by the color-coded arrows in Figure 7, where the possible signal exchange (set-points and measurements) between various control levels is highlighted.

Control Function	Transmission (T)/Distribution Grid (D)	Control Levels
Voltage/Reactive Power Control	D	L2, L1, L0
Frequency Control	T, D	L2, L1, L0
Rotor Angle Stability Support	T, D	L2, L1, L0

Table 4: Possible realization of control functions.

Two control concepts for ancillary service provision are defined and addressed based on the control architecture depicted in Figure 7, i.e. centralized control and decentralized control shown in Figure 8 and Figure 9, respectively.

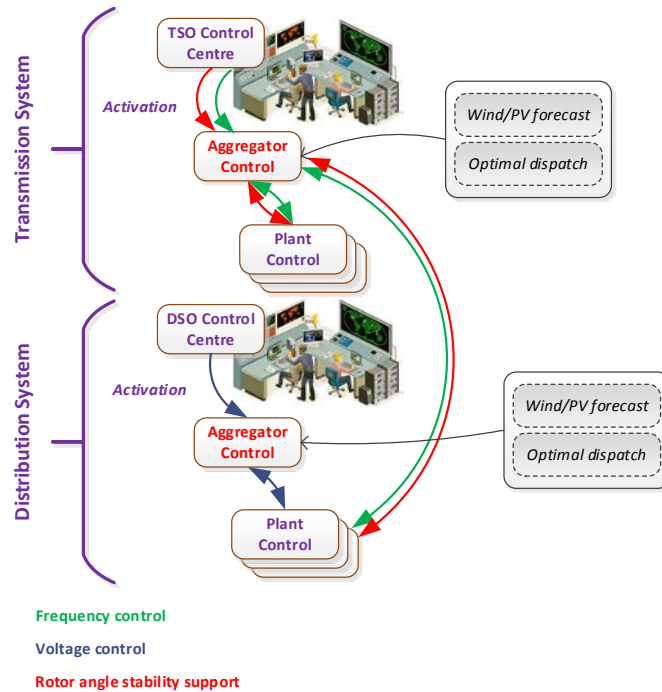

Figure 8: Centralized control architecture.

In the centralized control concept, depending on the power system status, the **Control Centre** activates certain control functions on the **Aggregated Control** level acting as the central controller. Optimal dispatch functionality and wind/PV forecast, accounting for the availability of the assets to provide a given AS are included in the aggregated control, as well as the measurements with the status of the assets (WP plants and PV units). The set points to the WP and PV plants are sent by the central controller according to the control and dispatch algorithm.

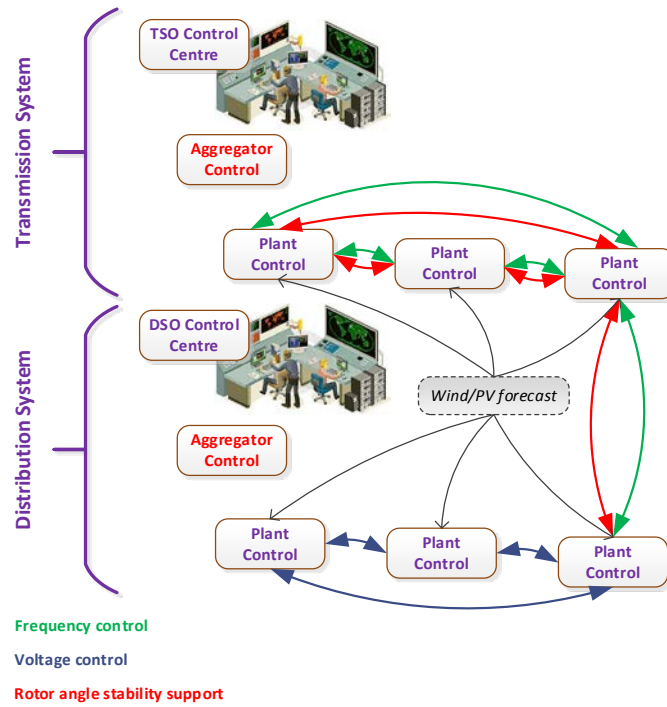

Figure 9: Decentralized control architecture.

In the decentralized control concept, each Plant Control (LO) can communicate with the other parallel local plant controllers with predefined characteristics depending on the control phenomena. Forecast methods can be used in this control concept for each plant individually to provide a given ancillary service, when feasible. However, optimal dispatch is not feasible for this control concept due to the lack of a centralized control element [2].

In the context of RePlan, coordination refers to the allocation/scheduling and configuration of functionality of assets to deliver a given ancillary service, taking into account the real time communication, the capabilities and availability of resources. For voltage control, secondary frequency control, POD, coordination refers to the allocation of resources to deliver a given service, taking into account the real time communication and the whole control levels chain. For fast frequency control, rotor angular control, coordination refers to the scheduling of the assets to provide their contribution to a given service. This scheduling indicate the reserve allocation (how much from each asset), order of their activation and the different moments in time when they are activated (i.e delay their response). Figure 10 and Figure 11 illustrate generic possible control coordination schemes for secondary voltage control and frequency control , respectively.

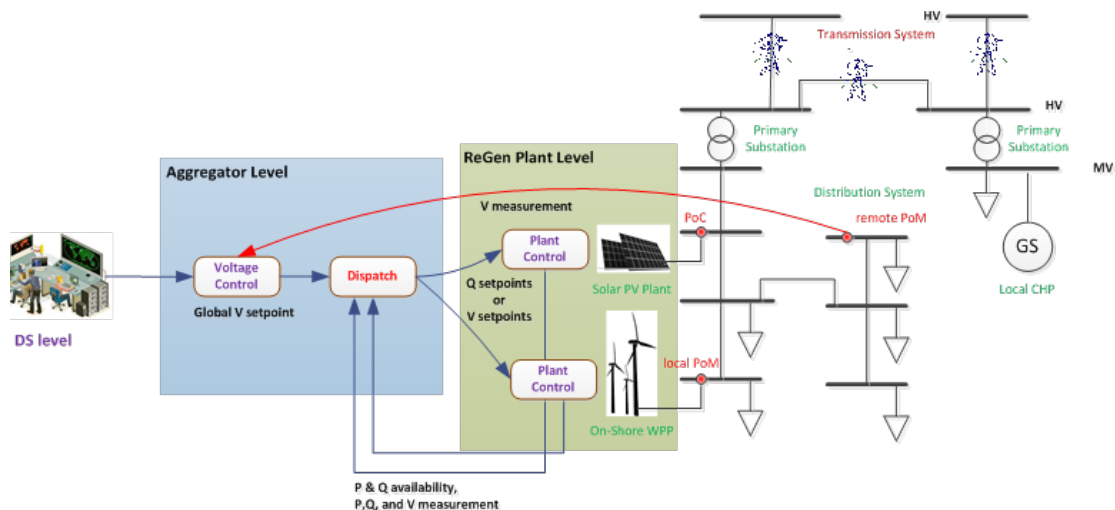

Figure 10: Control coordination by means of voltage control for distribution grids.

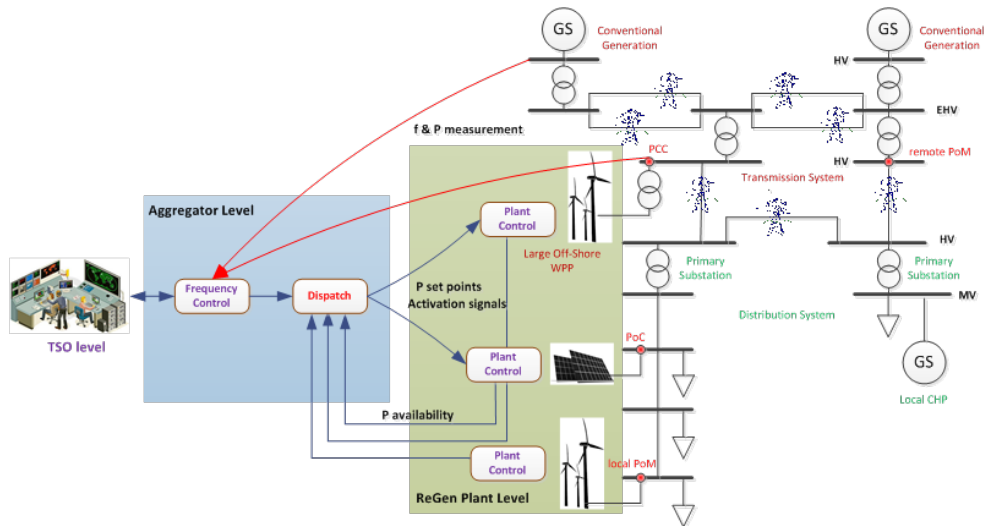

Figure 11: Control coordination by means of frequency control from transmission grids.

**WP1** has also analysed several highly relevant communication properties which at the end boil down to the amount of investment required to be done in order to support the control services envisioned. Communication is required for most cases to coordinate and ensure that measurements and set points are correctly exchanged between entities in the system. Figure 12 illustrates the RePlan communication scenario, showing how different assets in the RePlan scenario are connected together via a communication network [5].

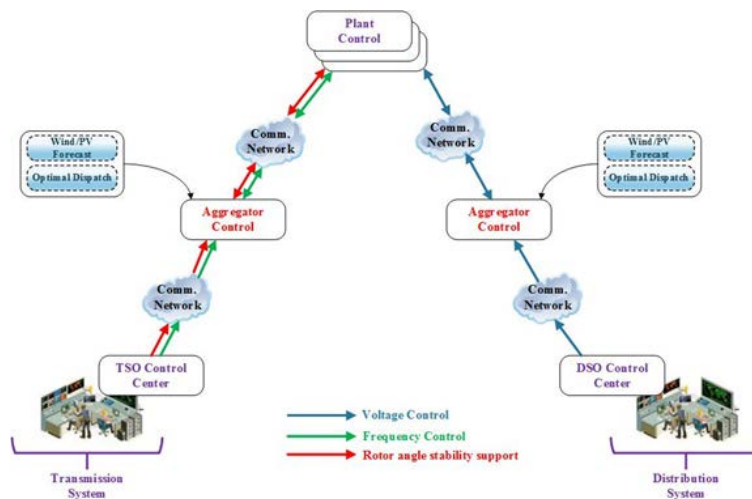

Figure 12: RePlan communication scenario.

Each communication network has its own requirements that may differ from one another in terms of coverage range, distance covered, the maximum data rate, maximum delay allowed, and the information access strategies used.

### 1.5.2 Voltage stability support (WP2)

The objective of this work package has been to identify voltage stability challenges related to the large penetration of ReGen plants into MV distribution systems, to develop controllers with the specific aim of regulating the voltage /reactive power and analyze the suitability for a coordinated voltage stability support from WP and PV plants in DSO distribution levels.

The voltage stability challenges in power systems with large penetration of ReGen are outlined. They are related to volatile voltage excursions in distribution systems due to ReGen plants. Some considerations regarding current penetration of wind power and Solar PV in distribution grids are made. Present challenges are addressed by real measurements given by a local DSO in Denmark. Based on the actual trend of increased penetration of both solar and wind, the challenges to be expected in future are illustrated by means of exemplary benchmark distribution grid Figure 13. It is observed that an increased penetration of wind and PV into the

distribution grids can lead to large voltage fluctuations and a high risk for exceeding the voltage limits. As a consequence disconnection of ReGen units is expected, but also damage of other equipment such as transformers, customer loads etc. The results are presented in references [6] and [7].

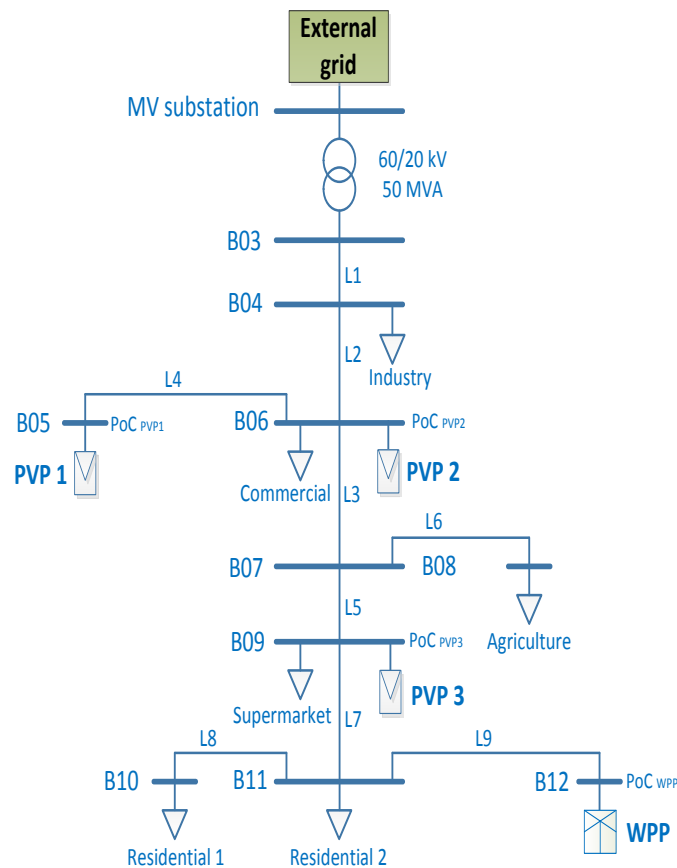

Figure 13: Structure of MV Benchmark Grid

Subsequently, it is presented the technical capabilities of ReGen plants for voltage control related to the required functionalities stipulated by the technical grid code requirements and the functional specifications that are described in [2]. Those functionalities enable the provision of voltage stability support from ReGen plants. The definition of the most important parameters is presented by means of state-of-the-art analysis. The results show that WP and PV plants are capable of processing received setpoints, offering certain amount of reactive power reserve and enabling reactive power control schemes as required by the grid codes.

In order to identify voltage stability challenges in distribution systems with large penetration of ReGen and to assess the voltage control functionalities developed in this report, a benchmark distribution grid is developed which is based on a real MV grid operated by Himmerland Elforsyning (HEF) near Aalborg in North Jutland. In order to verify the developed control concepts, performance models for ReGen plants are applied for the study cases. These aggregated models consider a maximum frequency bandwidth of 5 Hz and are applicable for reactive power / voltage control. The models are presented in reference [6].

Subsequently, a voltage sensitivity analysis is performed to quantify node voltage variations due to injections of active and reactive power for given operational points of the network. V-P sensitivity analysis has revealed some generic findings to quantify the expected voltage fluctuations due to active power infeed by ReGen plants, being dependent on both the location in the grid and the operational conditions of ReGen plants. Analysing V-Q sensitivity has shown that operational conditions do not affect the  $\delta V/\delta Q$  indices considerably. However, the various test cases evaluating different grid configurations have demonstrated that grid characteristics such as cable lengths and short-circuit ratio play a major role for the V-Q sensitivity at a certain bus. The  $\delta V/\delta Q$  parameters express to which extent voltage changes due to a deviation of

reactive power provision. This coherence is essentially applicable to a typical voltage droop control function with  $Q(V)$ . The detailed results are shown in references [6-8].

The results of the static analysis are taken into account to develop voltage control concepts. The architectures of the voltage control concepts are represented and their characteristics (i.e. requirements, implementation procedures, data exchange) evaluated. One concept of coordinating proper reference signals for voltage reference point and droop is referred to as *Distributed (or Decentralized) Off-Line Coordination* [6]. The idea of this approach is to determine the droop values of each ReGen plant controller by means of an initial static analysis of the DG, i.e. voltage sensitivity analysis, taking into account the impact of reactive power variations on voltage changes ( $\delta V/\delta Q$ ) in different points of the grid. Another control concept (*Distributed On-Line Coordination*) is characterized by real-time coordination of the local voltage controllers using the available measurements in the grid [8-9]. The idea is to reduce the reactive power loading and thereby the power losses in the grid by adjusting the voltage reference point at each ReGen plant according to the prevailing voltage profile within the grid.

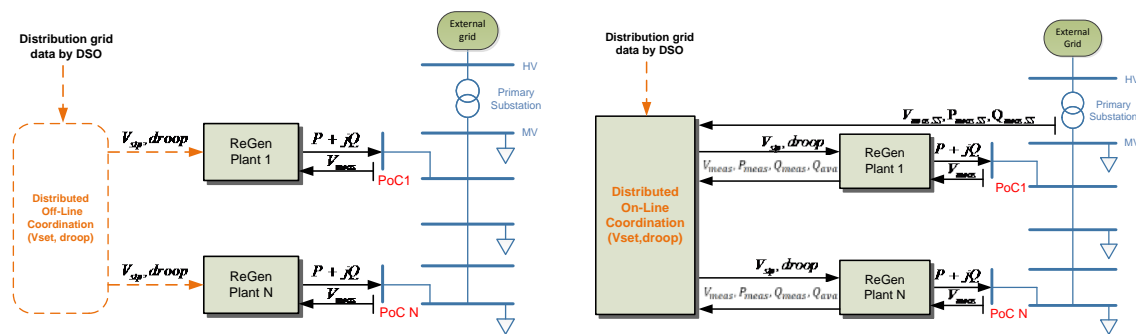

Figure 14: Control Concepts:

Distributed Off-Line Coordination (left) and Distributed On-Line Coordination (right)

Time domain analyses are performed in order to test the voltage control concepts for off-line coordination and on-line coordination respectively. The system models are used to analyze voltage control in time domain for a volatile power profile of the ReGen plants, used as a benchmark test scenario that covers the crucial operating points with high solar irradiation and wind speed. The control concepts are evaluated based on some crucial performance criteria, i.e. voltage profile management, stability of voltage control and voltage fluctuations, and target dependent performance criteria, i.e. reactive power utilization of ReGen plants and power losses.

One of the main results is that arbitrary droop settings of the ReGen plant controller can lead to temporary instability problems, if the droop characteristic of ReGen plants is too flat (Figure 15). On the other hand, deriving droop settings according to the system needs by V-Q-sensitivity analysis will lead to stable operating points.

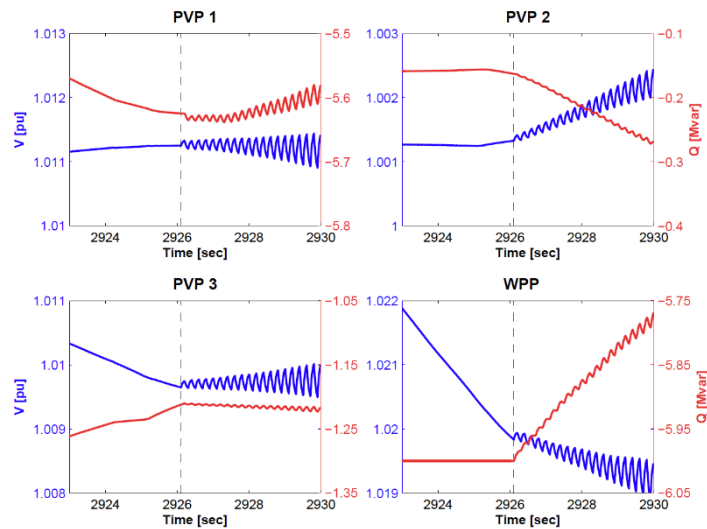

Figure 15: V & Q of all plants at beginning of instability at  $t_1 = 2926.1$  sec for DroopMin = 2 %

Another key result is that the power losses within the distribution grid, being introduced by the off-line coordination concept, are reduced to a measurable extent by on-line coordination of voltage reference points (Figure 16). A complete overview of all simulation results is given in reference [6].

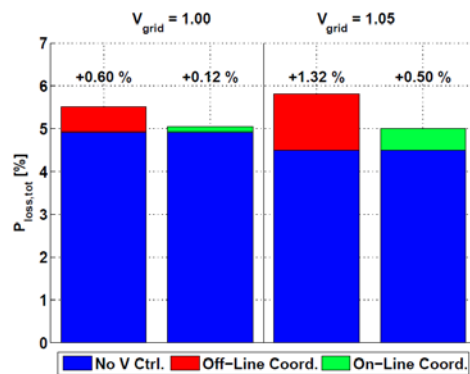

Figure 16: Power losses for various test cases and external grid voltages

Finally, the impact of ICT properties on on-line voltage control coordination has been investigated. Deliverable report [6] demonstrates that using the proposed algorithm in Control Concept 3 (CC3) for online voltage control coordination from ReGen plants, the overall performance of online coordination for voltage profile management, control stability and the present voltage fluctuations remained satisfactory. The power losses within the distribution grid have also been shown to reduce to a measurable extent. Moreover, using several test scenarios, deliverable report [6] ascertains that the aggregator should dispatch set-point signals to ReGen plants in time intervals of 10 seconds to few minutes. However, since the online coordination between ReGen plants and the system operator (i.e. DSO) depend upon the underlying communication infrastructure, this coordination might be affected with delays and failure in communication.

Figure 17 shows the line losses expressed as percentage of the total generated power by all ReGen plants, averaged over the simulation period of 24 hours, for both Control Concept 2 (CC 2 - constant voltage set-point) and CC3, without and with various communication failures.

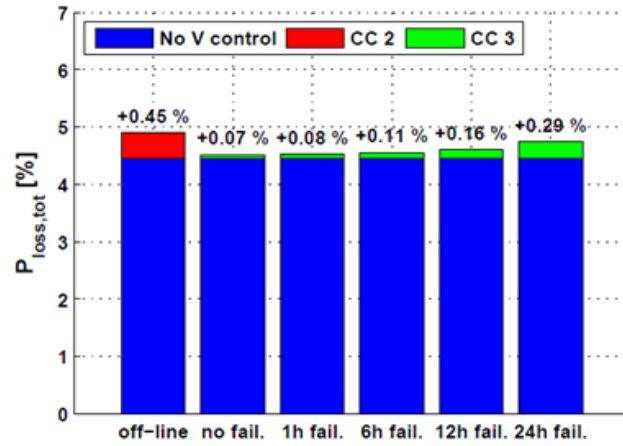

Figure 17: Power losses for various durations of communication failure for updating the voltage setpoints

It can be observed in Figure 17 that the power losses increase for longer communication failures. In Figure 18 the related voltage and reactive power profile is depicted, exemplary for a communication failure persisting for 12 hours.

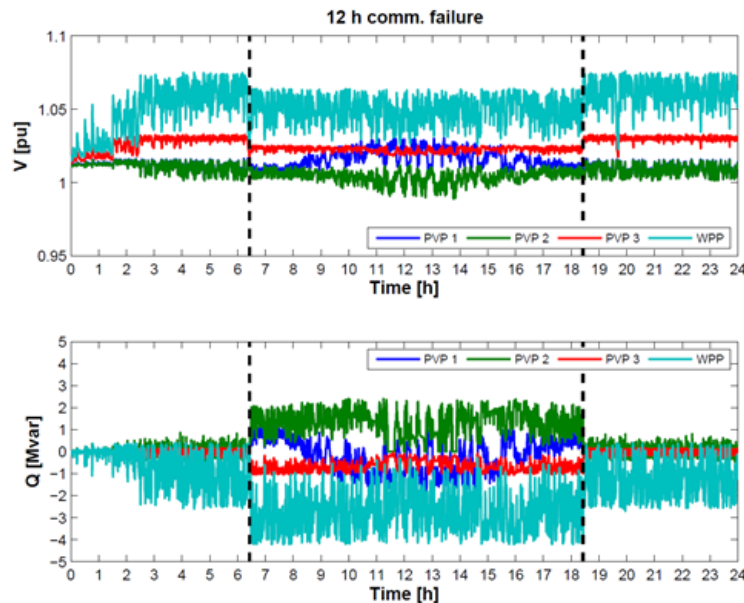

Figure 18: V and Q of all ReGen plants over one day for a communication failure occurring between 6 am and 6 pm

After occurrence of the failure at 6.20 AM the last sent voltage setpoint will be applied during the faulty period. This results in significant reactive power provision, since the voltage setpoint is not anymore updated according to the voltage measurements, hence increasing the power losses in the system.

Furthermore, it has been ascertained in [6] that relatively flat droop characteristics of the local voltage controller in the ReGen plants lead to instable voltage regulation within the distribution grid due to hunting effects between the individual controllers. In case of a cyberattack, if a hacker is able to manipulate the droop values accordingly, by attacking the Aggregator control unit and sending updated reference signals to all ReGen plants, severe grid situations can occur. This is illustrated by Figure 19, which shows the voltage and reactive power profile for a case when all droop values are set to 0.5 %, leading to a very flat droop characteristic.

At  $t = 500$  s, the cyber-attack is initiated, leading to subsequent voltage oscillations. At  $t = 524$  s, the WP plant experiences a voltage exceeding the limit of 1.1 pu and needs to shut down. Voltage oscillations between all PV plants sustain, until PV1 shuts down at  $t = 795$  s due to overvoltage.



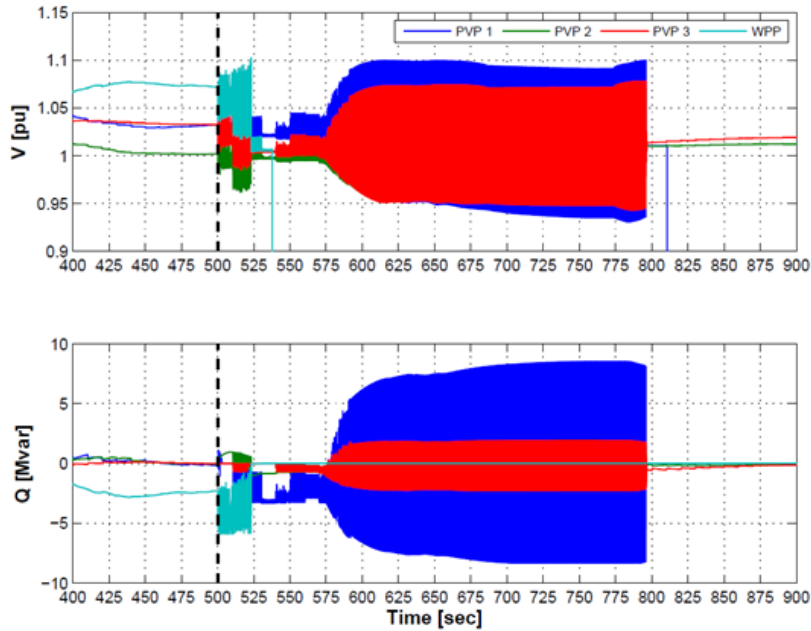

Figure 19: V and Q of all ReGen plants when subject to a cyber-attack (manipulating droop value at  $t = 500$  s)

Figure 20 shows a case where the hacker was capable of manipulating the voltage setpoints being sent from Aggregator to the ReGen plants. At  $t = 500$  s, a reference signal of  $V_{set} = 1.08 pu$  is sent to all ReGen plants, which instantaneously leads to a rising voltage profile in the distribution feeder. At  $t = 567$  s, the WP plant shuts down due to overvoltage. The remaining PV plants will eventually provide reactive power (+Q) to boost the voltage according to the droop characteristic with the relatively high voltage setpoint.

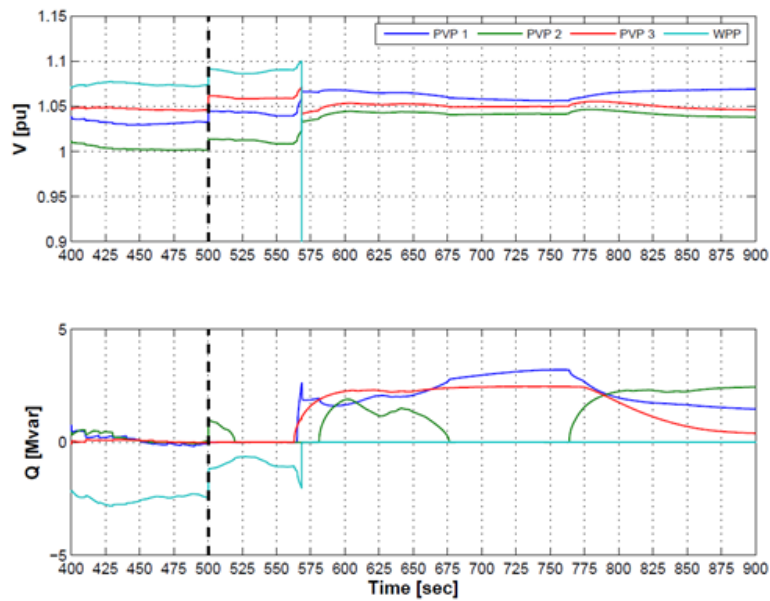

Figure 20: V and Q of all ReGen plants when subject to a cyber-attack (manipulating voltage setpoint at  $t = 500$  s)

The impact of communication properties on online voltage control coordination can be summarized by means of Table 5:

Communication Effects	Impact on Power Losses
False message signals	Critical
Latencies (several hours)	Medium
Latencies (seconds to minutes)	Low

Table 5: Impact of communication properties on online voltage control coordination.

Communication aspects related to the network infrastructure, protocols and possible cyber-attacks have been evaluated with respect to the related latency and validity of the signals being exchanged between Aggregator and ReGen plants, resulting in deviating voltage control performance in the distribution grid. Latencies in the network do not affect the delivery and coordination of voltage service with respect to stable voltage profile management. However, present latencies in the range of several hours e.g. due to communication failures can increase the power losses within the grid due to less optimized control coordination. Special attention needs to be paid to cyber-attacks, since false message signals being set to the ReGen plants can cause instable operation of voltage control. A comprehensive overview has been given in references [6] and [9].

The results of **WP2** yield in some recommendations for national Danish Grid Codes (i.e. adjusting the required reactive power capability of PV plants), the Distribution System Operators (i.e. regarding the evaluation of voltage fluctuations and grid power losses) as well as Aggregators of grid support services (i.e. regarding the parametrization of voltage control functions in ReGen plants and the placement of the central aggregator control unit).

### 1.5.3 Frequency stability support (**WP3**)

The potential economic and technical benefits of employing frequency support from ReGen power plants make the research topic getting higher attention recently, even though there is a big concern regarding reduced power system inertia and ReGen power plant's fluctuating power output. Regarding the response time of the frequency support, fast frequency response (FFR) and frequency restoration reserve (FRR) have been investigated in this work package separately.

Regarding FFR, an optimization approach has been developed at the transmission system operator (TSO) level to coordinate the FFR of WP plants. By using the results of the optimization study, it is shown that it is possible to improve the frequency nadir in the majority of the considered scenarios. Employing the optimized parameters of FFR, the impact of the ICT on the power system frequency response is also investigated. Furthermore, the overproduction of the wind turbine (WT) capability is explored.

Regarding FRR service, a control method applying a statistical online decision making system has been proposed. It has been seen that this can reduce the amount the average output from WP and PV plants has to be lowered to ensure delivery of the FRR service by optimally calculating the power plant set points. As a result, the proposed method can improve the economics of the ReGen power plant while respecting the frequency service performance requirement. The method uses a statistical approach to calculate the maximum base power setting that makes the expected mean control error less than 1%. This 1% control error is allowed by the TSO. The method considers multiple wind power scenarios and various possible regulation signals. The two case studies of wind power plants and PV power plants in [10] show that the base power setting can be increased significantly compared to the most conservative setting.

**WP3** has mainly focused on:

- Power system model development for FFR
- Offline Optimization Approach Development for FFR of WP plants
- FRR control principle
- ICT impact on FFR

#### Power System Model Development for FFR

A generic large scale power system model has been implemented and simulated in order to analyze the need for a coordinated FFR from WP plants and also investigate the impact of the FFR parameters on the frequency control dynamics of the power system. The frequency control dynamics of a generic large scale power system has been represented as a single-bus model including various governor and turbine models such as steam, hydropower, and nuclear power plants. This model is illustrated Figure 21. It is adapted from PEGASE Pan-European model [11] in order to simulate 4th November 2006 incident in ENTSO-E.

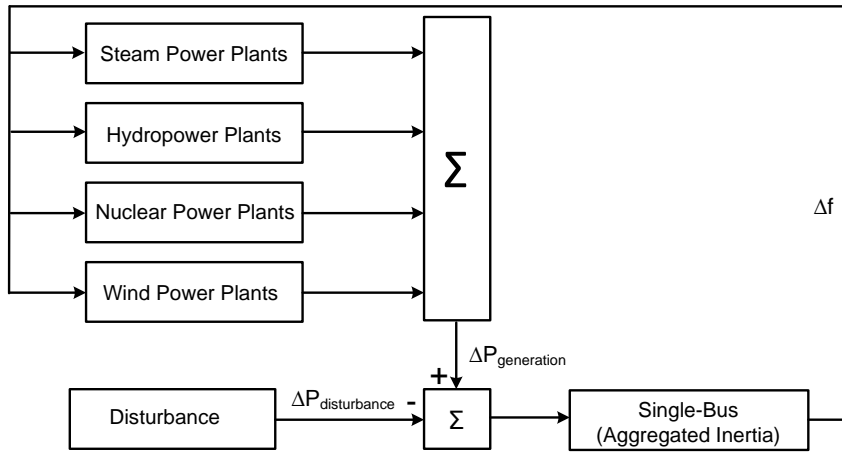

Figure 21: Single-bus model of a generic large scale power system with WP plants

Different wind power penetration levels have been implemented in this model in order to reduce down the inertia by replacing steam and nuclear power plants. Different penetration levels of wind power are assumed as scenarios in this study. These scenarios are summarized in Table 6. The penetration level is defined as the ratio of wind power generation to total power generation.

Penetration [%]	Total Generation [GW]	Steam [GW]	Hydro [GW]	Nuclear [GW]	Wind [GW]
10	68	45	6	10	7
20	68	38	6	10	14
30	68	33	6	8	21
40	68	31	6	4	27
50	68	25	6	3	34

Table 6: Different Wind Power Penetration Scenarios.

Offline Optimization Approach Development for FFR of WP plants

An optimization approach has been designed for parameter tuning of the FFR in WP plants. The optimization approach consists of the power system model, which has conventional power plants, the wind power plants with the FFR implementation and the optimization engine. The illustration of the optimization approach is given in Figure 22. As mentioned earlier, this framework is used for the aggregated and distributed FFR of WP plants. This developed approach is implemented in the TSO level. Since TSOs have full control and information on their area, the optimization approach can be simulated offline in TSO level (i.e. in the planning stage of the FFR).

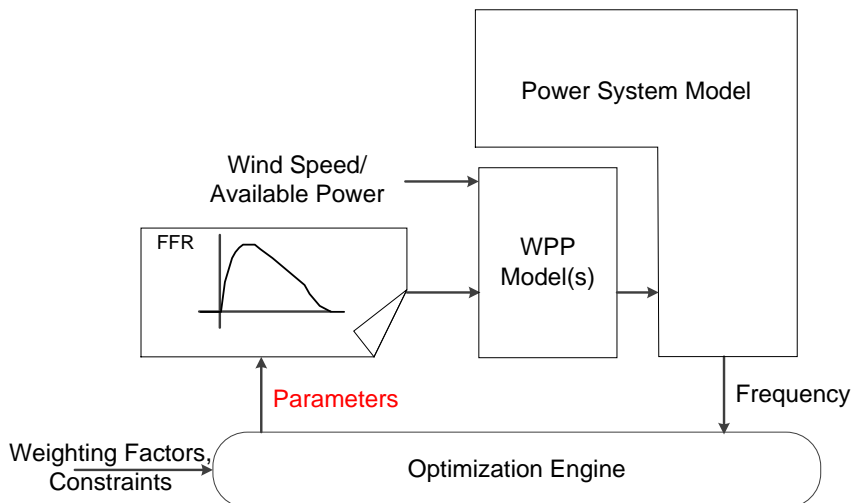

Figure 22: Illustration of the Optimization Approach of FFR from WP plants.

In Figure 23, the control structure is illustrated including TSO level, aggregator level, and plant level. In the planning stage at the TSO level, the optimization engine (Figure 23) is running and generating the optimum parameters depending on the different wind speeds/available power. These optimum parameters are sent to the aggregator level which can be owned by the WP plants owners. In the aggregator level, depending on the available power values of WP plants, the parameters are dispatched to each WP plant. After the dispatch through communication infrastructure, the parameters are sent to each WP plant. According to the control structure, the FFR is implemented in plant level, the dispatch is in aggregator level, and the optimization engine is in TSO level. The communication channels are mainly used between the aggregator and plant levels [10].

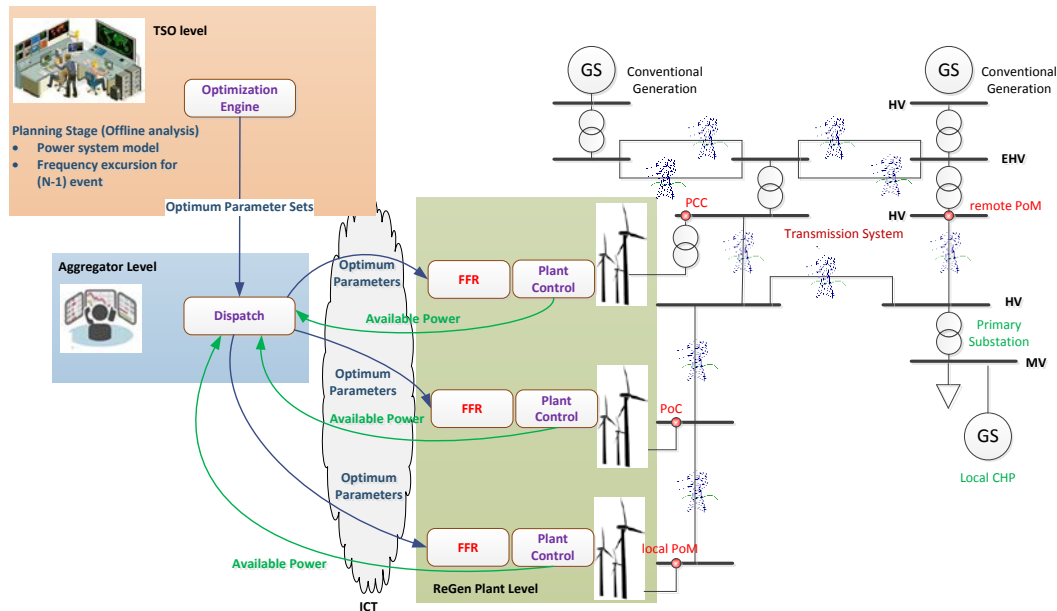

Figure 23: Implementation of Offline Optimization Approach with Control Levels.

Figure 24 depicts some examples of the results obtained in **WP3**. All the WP plants have the same wind speeds in each case as 7, 11, and 14 m/s respectively. Additionally, the previously obtained parameters in the aggregated FFR optimization are employed in each WP plant. The simulations are performed and compared in terms of power system frequency (Blue line in the power system frequency results) with the coordinated FFR. Several improvements of the coordination have been reported in [10]. Based on these studies, ICT impact on the FFR support from WP plants is also investigated, including the related models, methodologies and case study considered in [10].

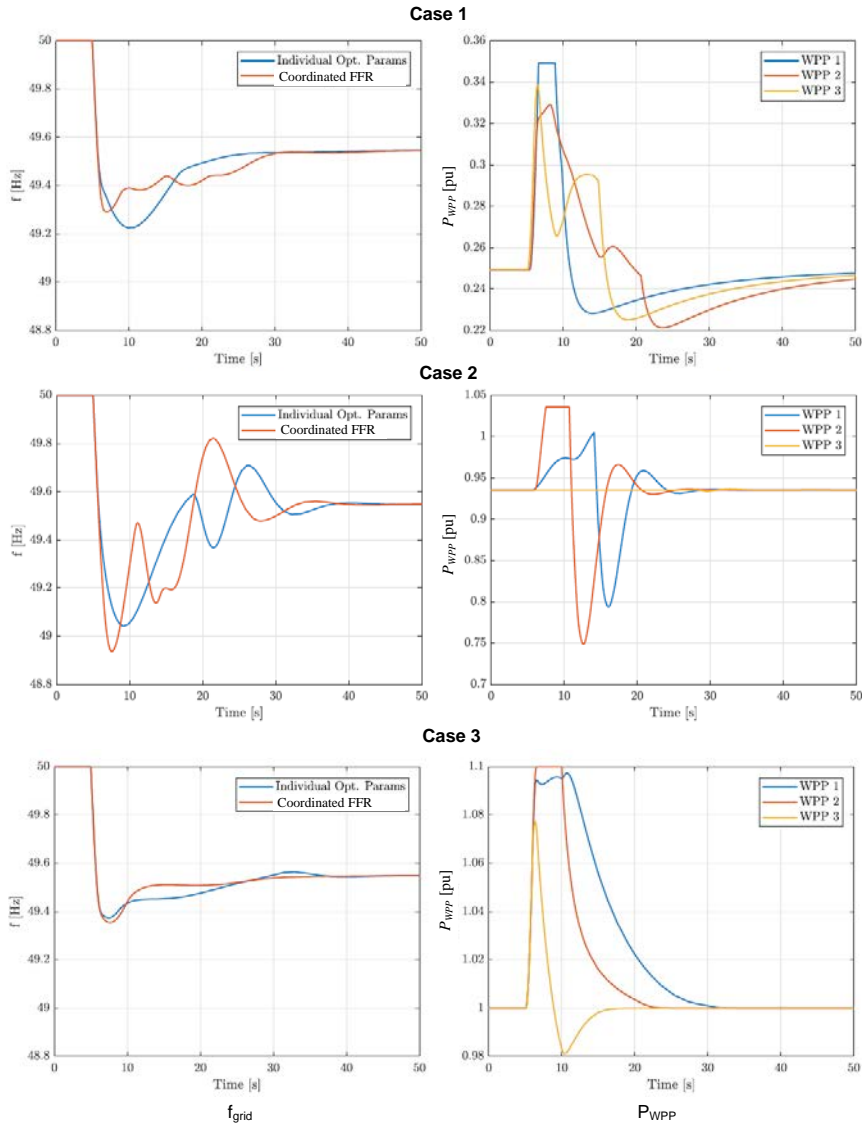

Figure 24: Power system frequency ( $f_{grid}$ ) and WP plants' active power outputs (PWPP) at uniform wind speed conditions

### FRR Control Principle

FRR is a so-called secondary reserve and it could be procured daily, weekly or monthly dependent on the rules in different power systems. In this study, it is assumed that the TSO buys the secondary reserve on a daily basis from service providers (e.g., balance responsible parties nowadays, aggregators in the near future power system), considering the increasing penetration of renewable energy resources which is hard to predict in a long term horizon. The secondary reserve consists of upward and downward regulation reserves which are requested as a combined, symmetrical reserve. The service is delivered in real-time operation as an automated control reacting to a signal provided by Energinet.dk. The regulation signal is sent online every 4 seconds as an output value from Energinet.dk to each service provider. The regulation signal is normalized within  $r \in [-1, 1]$  relative to the reserve amount and the aggregator uses it to provide the balancing power.

### Online FRR Control Development for ReGen Plants

The objective of the control is to ensure that the quality of the delivered service is within the requirements of the system operator while the amount of RE power from the participating ReGen power plants is maximized. This is illustrated in Figure 25. In this figure the objective is to move the  $P_{sch}$  as far high as possible while keeping the probability that  $P_{sch} + r \cdot P_{res}$  is not met within the specified requirements e.g. 1% of the time. A control method that uses a statistical approach to calculate the  $P_{sch}$ -references to the ReGen power plants has been developed [10].

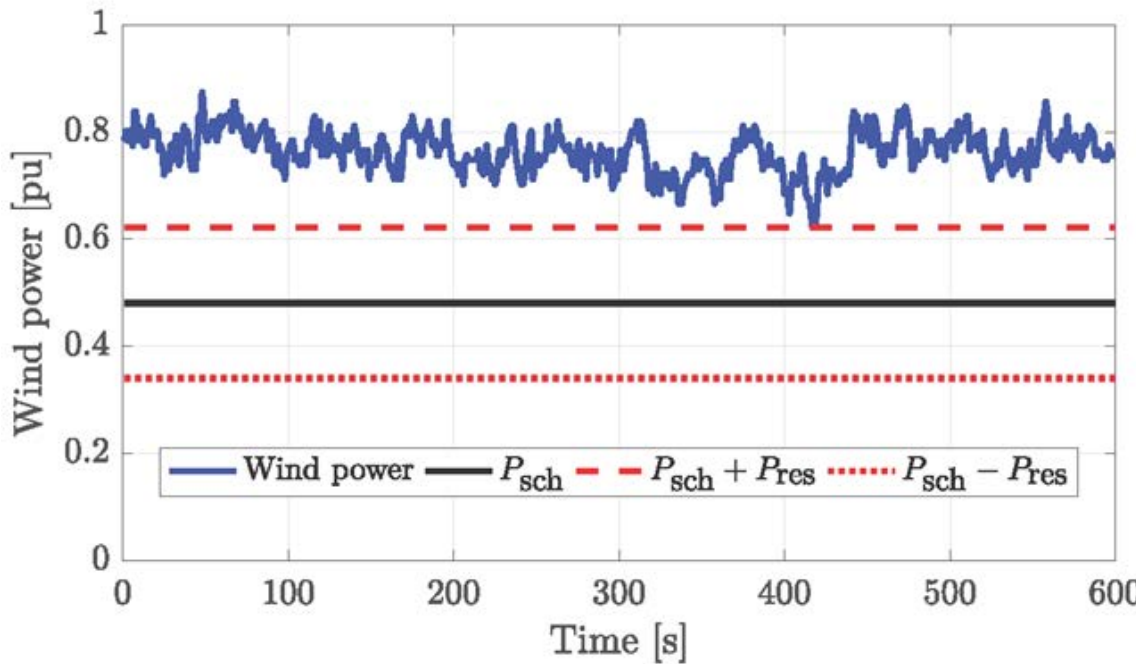

Figure 25: FRR from WP plant. Robust service provision by ensuring  $P_{res}$  can be provided at all times

An aggregator level is proposed to coordinate the ReGen plants's power output in order to provide secondary frequency regulation services to transmission system operators (TSO). It is assumed that the reserve capacity  $P_{res}$  of each aggregator is symmetrical and at least being hourly constant throughout a period of 24 hours. Note that how to optimally make the day-ahead energy/reserve schedule of ReGen plants is not the focus of this study, the readers are referred to [10] for that purpose. The time period for service delivery is broken down into e.g. 5min intervals and just before each new 5min interval a forecast of the output for the interval is calculated and the  $P_{sch}$  for each participating ReGen power plant is determined based on the previous performance and the prediction and the values are communicated.

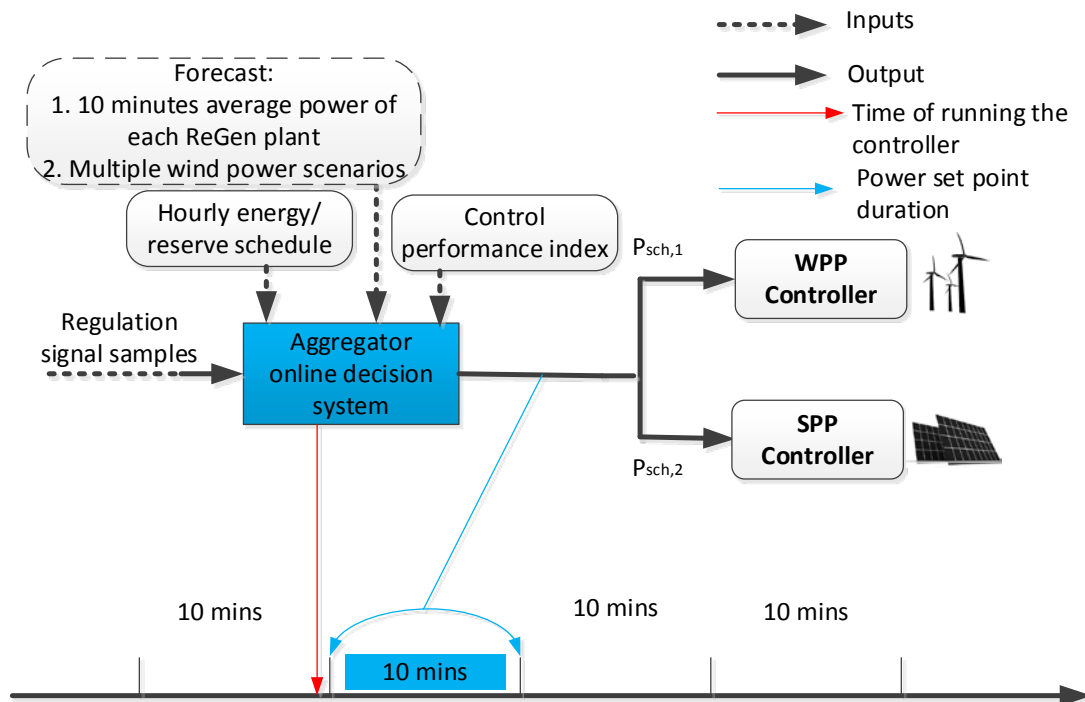

Figure 26: Control system overview.

Within the interval, the aggregator receives the regulation signal from the TSO and sends it to each ReGen plant. After receiving the regulation signal, each ReGen plant calculates the power set point as the sum of the  $P_{sch}$  and required FRR contribution. Note the control system is an open loop; however, the power measurement of each ReGen plant is needed to quantify the control error as well as to redefine the control performance index (see discussions in Section 5.3.3., [10]). The verification of the proposed method for real-time operation will be reported in Replan Project WP5 deliverables.

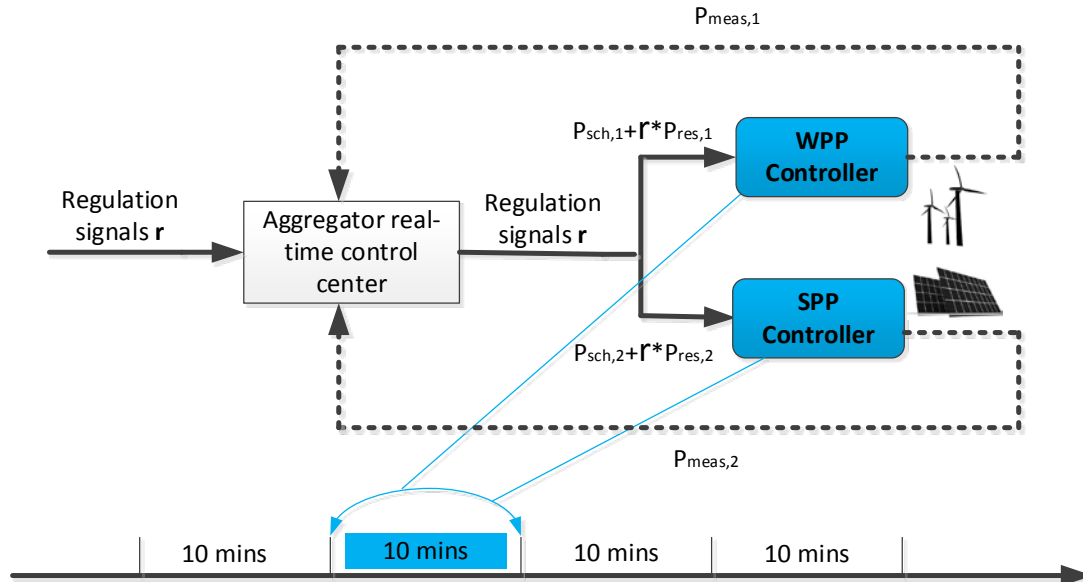

Figure 27: Real-time control operation

#### ICT impact on FFR

The ICT impact on primary frequency control from Regen plants has been investigated. When it comes to provide online frequency support and coordination from power generation plants [10], there is a need to add supervisory control and data acquisition (SCADA) communication to the intelligent electronic devices (IEDs). Fiber-optic cables are an extremely reliable means of transporting information between the control center (aggregator/TSO) and remotely located ReGen plants. Fiber-optic cable has the following advantages over copper cables: isolation from ground potential rise, prevention of induced electrical noise, and elimination of signal ground loops. However, for wide-area SCADA network, fiber-optic cabling installation can be expensive and slow. Wireless networking offers a cost-effective alternative to running fiber-optic cable in this regards. Wireless networks, specifically cellular networks, can provide up to 90 percent savings versus installing fiber-optic cabling, with greatly expedited implementation. The cellular networks have become the dominant mode of communication for machine-to-machine (M2M) communication as in smart grids and therefore opted to be tested to provide online frequency control service in [10].

Since the delay and other communication properties (such as packet loss etc.) in cellular networks are non-deterministic, it is worth exploring the exact range of these properties for analyzing the impact of using these networks to support frequency control and coordination from ReGen. The range of delays and packet loss probabilities, specifically for Denmark, are discussed in [10].

Moreover, there are different test cases and scenarios defined in [10] to elaborate and demonstrate the impact of using cellular communication networks for the provision of online frequency control service. These test cases are summarized in Table 7.

	Wind Power Plants		
	Offshore (Above 100 MW)	Onshore	
		Medium (50-100 MW)	Small (<25 - <50 MW)
Network Connections	Private	Private	Private
	Private	Private	Public
	Private	Public	Public

Table 7: Test Scenarios based on Network Connections

Table 7 shows three types of WP plants connected to the power system with different size in MW. It is important to note that these three WP plants are assumed to have the same contribution (i.e.  $\approx 33\%$ ). While regarding the network connections, there are three test cases defined i.e.

- All WP plants connected via **private** networks,
- Large share of WP plant connected via **private** and only 33% connected via **public** networks, and
- Large share of WP plant connected via **public** and only 33% connected via **private** networks.

For all private connections, the results were observed to be same as compared to those presented in [10]. However, Figure 28 and Figure 29 present the results for the other two test cases:

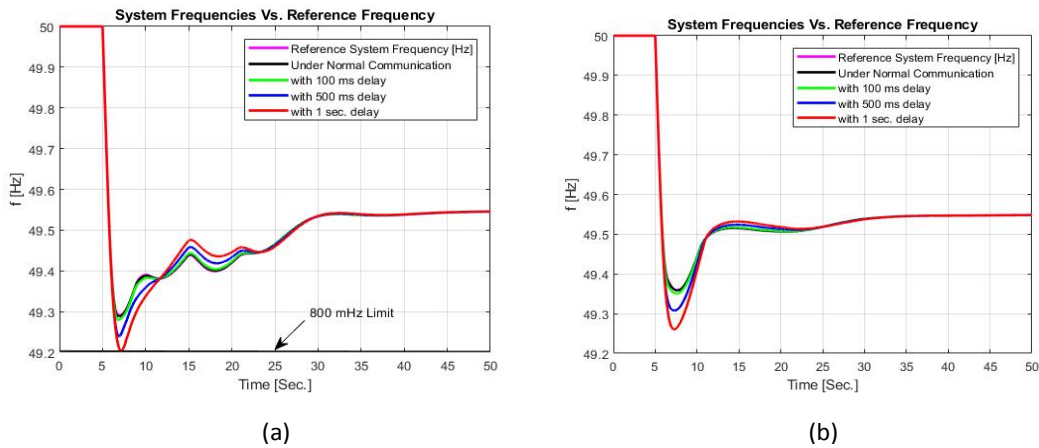

Figure 28: System Frequency under different delay conditions compared to the Reference Frequency at (a) Partial Load and (b) Full Load

Based on the results for test case 2 as shown in Figure 28(a), it can be concluded that the frequency nadir is decreasing with an increase in communication delays in public networks. The frequency limit of 800 mHz is reached for delays of around 1 second. While in case of Figure 29(b), by increasing communication delays the frequency nadir is lowered as well as the time to reach it.



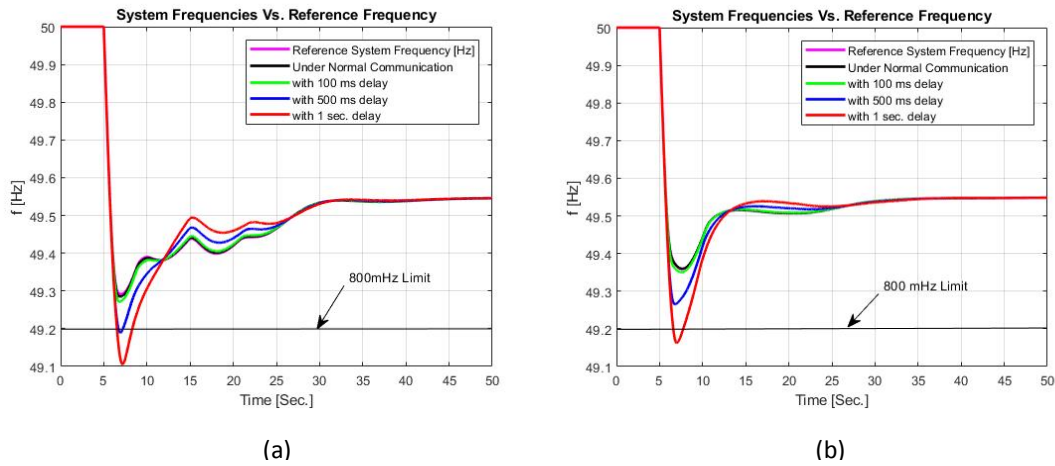

Figure 29: System Frequency under different delay conditions compared to the Reference Frequency at (a) Partial Load and (b) Full Load

In test case 3, the results reveal that having a large share of ReGen plants on public communication networks degrades the overall optimum response of grid frequency. Both frequency nadir and time to reach it decrease with increasing delays. The load shedding limit of 49.2 Hz is exceeded for delays of 1 sec.

ReGen power plants are capable to provide both FFR and FRR for the future power systems. Based on the findings in **WP3**, in order to make the control a success, it is recommended that:

- For FFR:
  - The coordination depends on the available power of each WP plant and the wind power penetration level. Accordingly, the response of WP plants can be coordinated by enabling the WP plants with high wind first and then using the WP plants with low and medium wind speed conditions. It has been seen that in scenarios with a large amount of wind generation operating at medium wind speeds, some WP plants have been dispatched to react not on the initial frequency drop but on the second dip caused by the frequency support of the other WP plants. In that way, it has been possible to alleviate the severity of the second dip.
  - According to the results of WT capability investigation, the maximum energy can be extracted depending on the overproduction power setpoint, the duration of the overproduction, and the operating conditions of the wind turbine for different wind speeds. Additionally, it is seen that for different wind turbine sizes, the optimum energy is released around the same wind speed region.
  - Design and tuning methodology for FFR must account for the delays in ICT especially when using public networks.
  - Coordination and activation of ReGen plants for provision of FFR must account for the ICT delays.
  - Communication delays have a large impact on the overall response of ReGen plants on system frequency. Frequency nadir and time to reach it decrease with increasing the delays [10].
  - Public networks are more prone to affect the overall frequency response due to stochastic nature of the delays compared to private ones where the delays are fixed and have low values.
- For FRR:
  - Improved ReGen power predictions that include expected and confidence intervals will improve the performance;
  - If the aggregator has more ReGen power plants, it is recommended to keep the predicted ReGen power scenarios small, since the online decision system

needs to take more computational time to compute the control error of all ReGen power plant setting combinations;

- When constructing the ReGen power scenarios, correlations between different ReGen power plant's power output could be considered which give a more accurate power scenario input to the online decision system; The scheme can also handle transfer of generation from one ReGen power plant to another if the power plant cannot deliver the anticipated output; Instead of using expected mean error index, the aggregator may use other error index to quantify the base power, such as percentile-based value.

#### *1.5.4 Rotor angular stability support (WP4)*

**WP4** was aiming to investigate the feasibility of Rotor Angle Stability support from ReGen Plants connected to power system. The work performed in this workpackage is captured in [9]. Considerations about observability and controllability of LFPO taking into account aggregation of this service but also some ICT aspects are made starting from a small signal stability analysis of a representative power system with various penetration levels of ReGen. This analysis was providing insight on which capability of ReGen Plants namely active or reactive power shall be utilized for enhancing the Rotor Angle stability Support. Also, identifying feasible measurement points to provide the required functionality was in scope. Considerations about impact of ICT on overall control schemes for PSS like functionality from ReGen plants are made.

A small signal model of a representative power system capturing the relevant low frequency oscillations has been used from a previous PSO project. The original model has been expanded to include renewable generation with penetration levels up to 50% but also to accommodate wind and PV plants.

An analysis of the mode shapes for different ReGen penetration levels has shown in Figure 30 that the mode shapes for all of the oscillatory modes are changing. Thus, frequency oscillations are expected to change when increasing renewable penetration. This behavior is showing that a given tuning of damping controllers used in power grid i.e. Power System Stabilizers in conventional power plants must be reconsidered for particular renewable penetration.

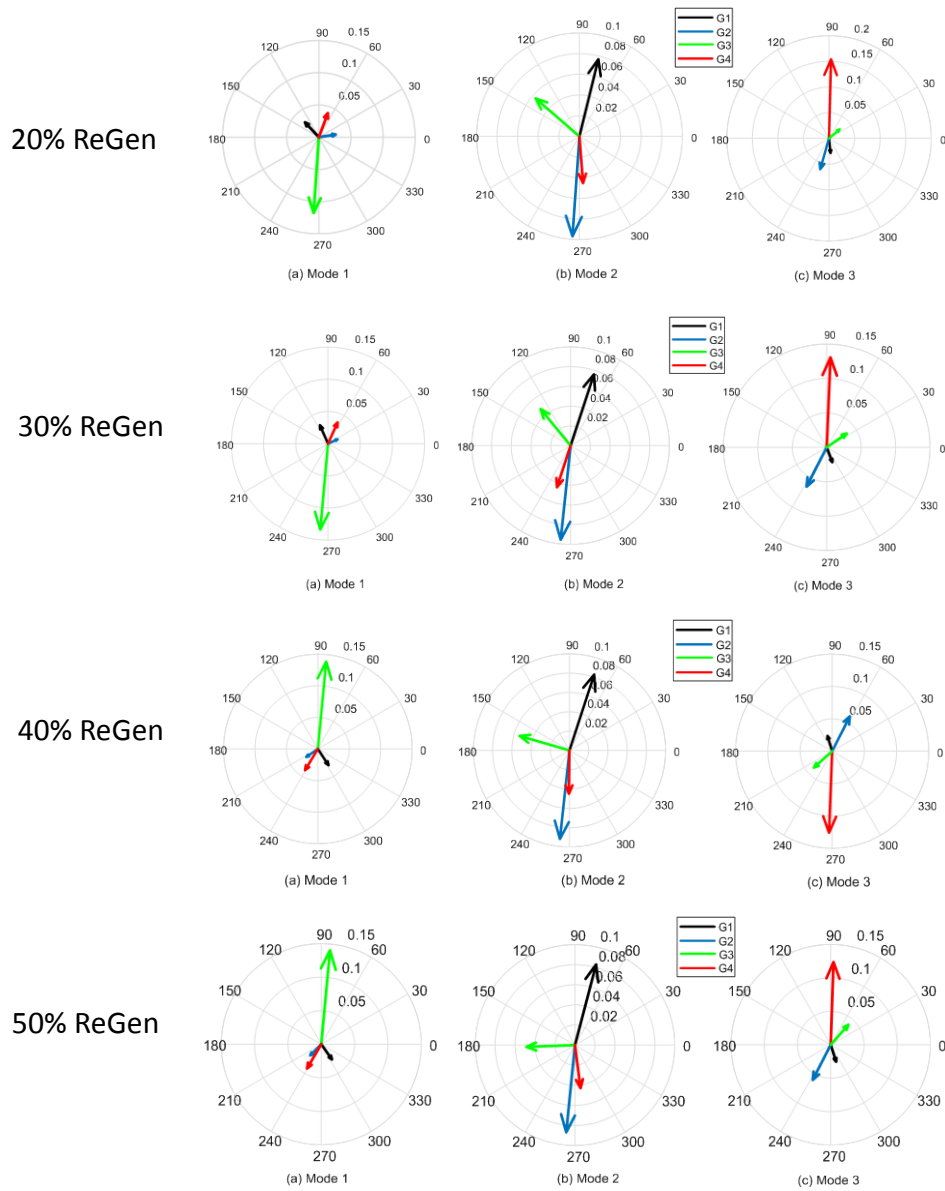

Figure 30: Evolution of mode shapes in increased ReGen scenarios.

An analysis of the normalized participation factors shown in has revealed that the contribution of conventional generation units to mode shapes is not affected by increased penetration of renewables into the power system.

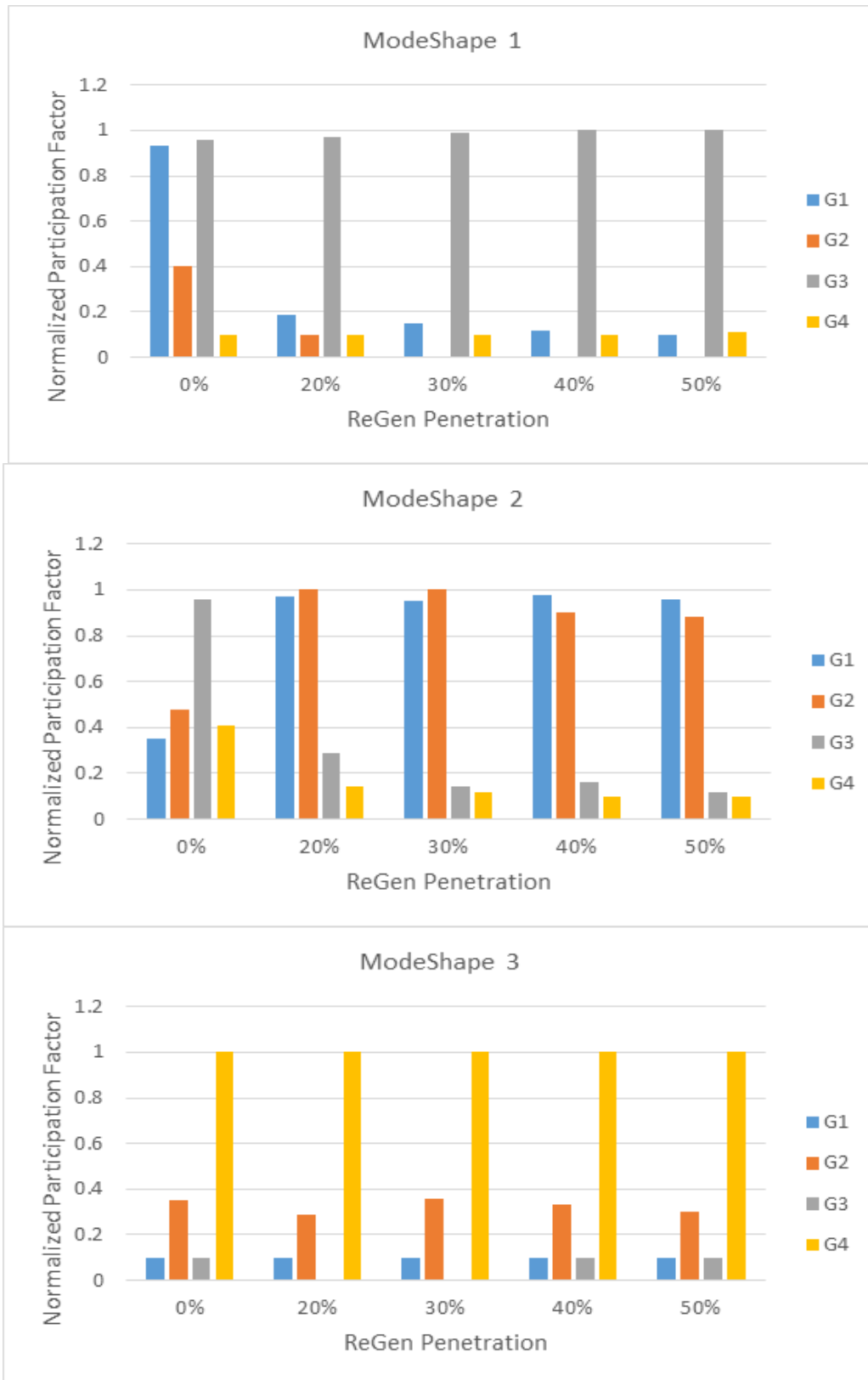

Figure 31: Normalized participation factors of Generator speeds for Mode Shapes.

It is rather important to observe how for different variable types the relative observability is distributed throughout the system. Two types of measurements/variables can be considered to monitor the LFPO into the power grid. First choice is to consider a direct measurement of the rotor angle/speed in each conventional generation units. The analysis of normalized observability of rotor angle/speed is shown in Figure 32.

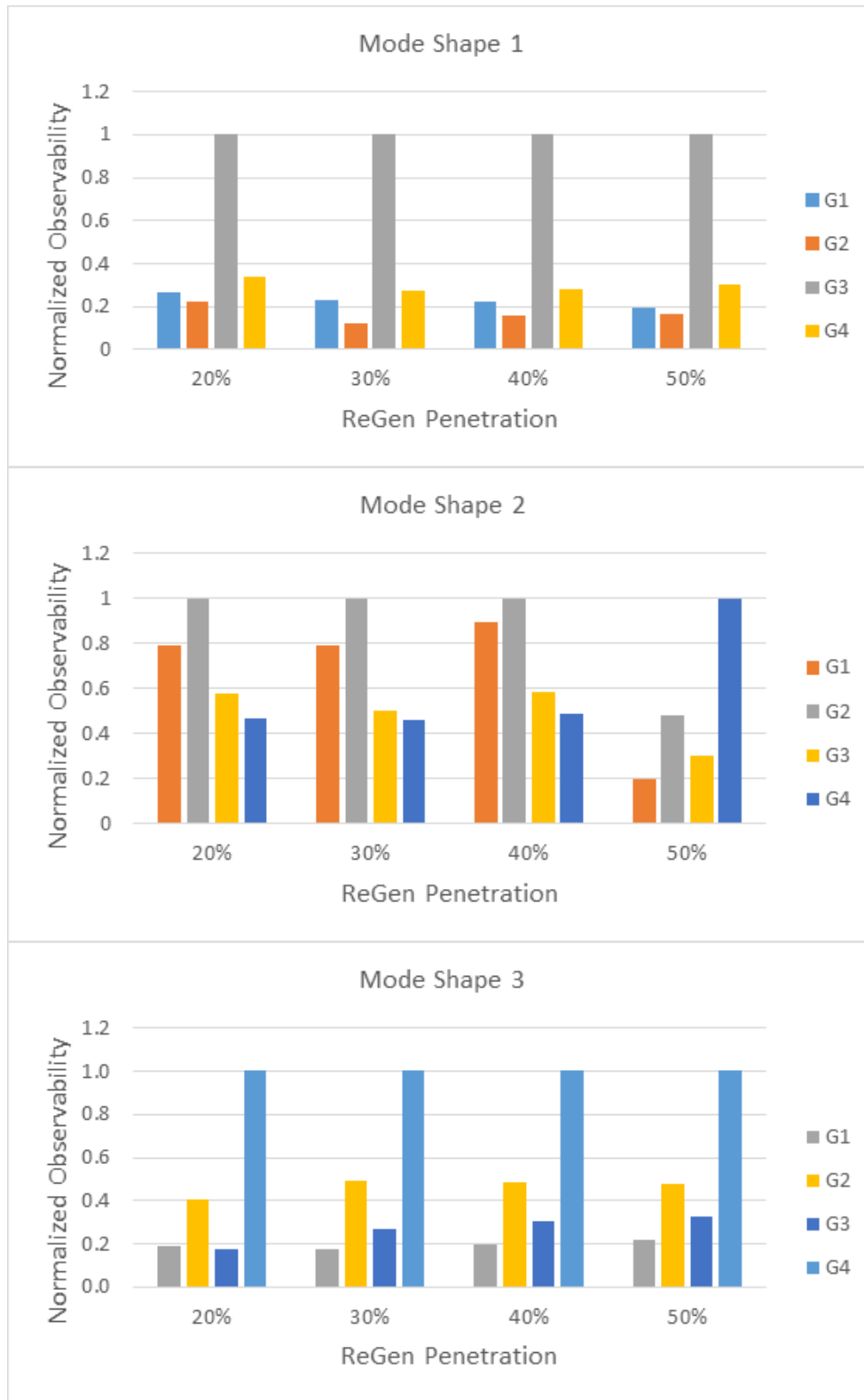

Figure 32: Rotor Angle based Observability of Mode Shapes

However, measuring the rotor speed/angle in conventional generation units and utilize this measurement in power damping control schemes will involve interactions between TSO and different plant owners/aggregators. Hence, challenges posed by communication and synchronization of the measurements. Thus, this option may not be feasible in practical setups.

An analysis of normalized observability of mode shapes when measuring the bus voltages is shown in Figure 33. It is relevant, in this case, to consider mainly the Point-of-Connection of Regen plants i.e. Bus 3, Bus 4 and Bus5, where the aggregated ReGen plants are connected. Based on the results for this particular systems it can be concluded that Mode Shapes are seen differently on each bus and thus effectiveness of any action for damping the oscillations with

these frequencies is different. Another relevant conclusion is that the observability is not affected by ReGen penetration.

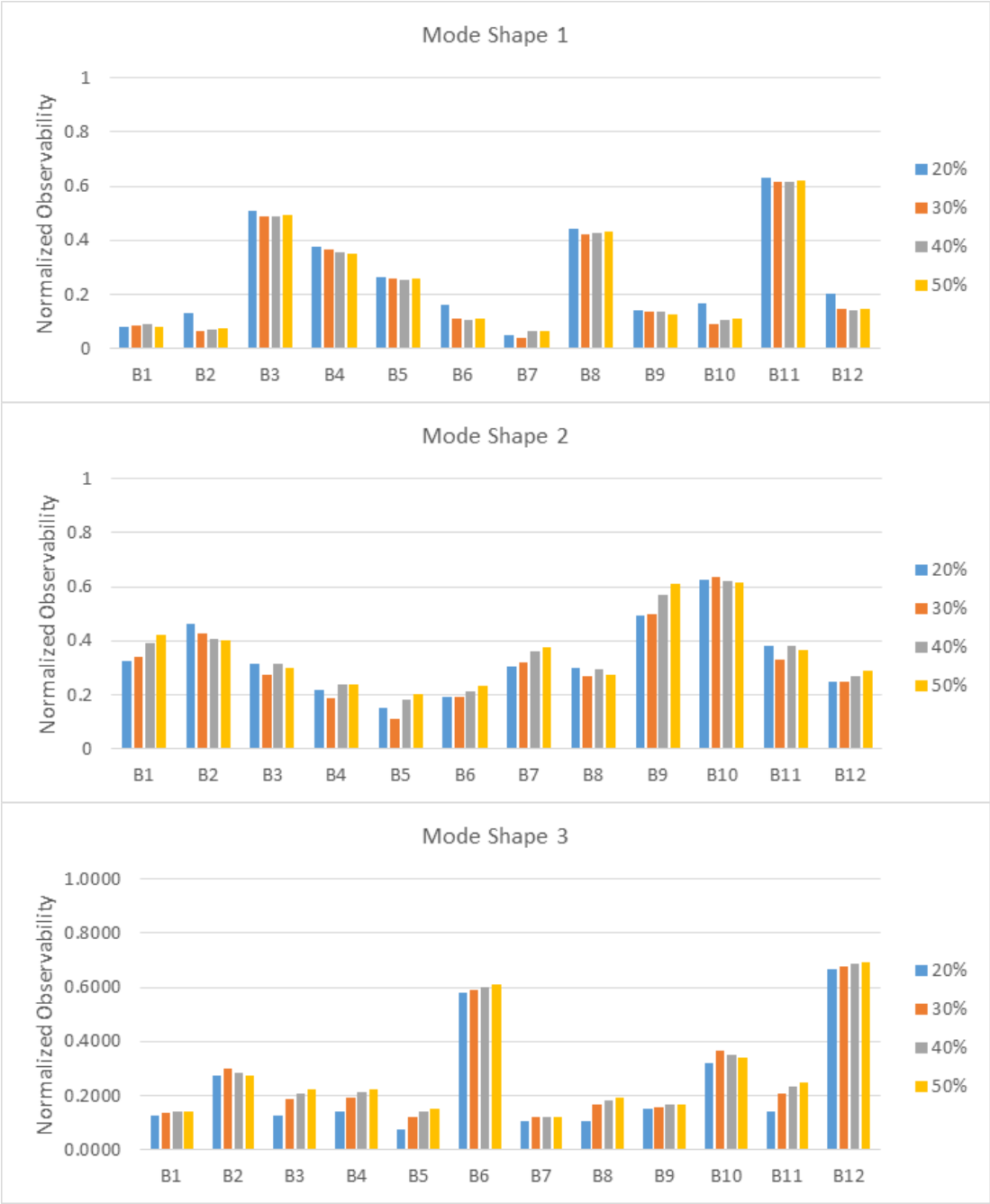

Figure 33: Bus Voltage based Observability of Mode Shapes.

The final analysis is concerning the controllability of mode shapes which is revealing how effective active and reactive power injection is in a specific bus on damping of a particular mode shape. Following the previous analysis only the buses where ReGen plants are connected were analyzed. The results are presented in Figure 34, Figure 35 and Figure 36.

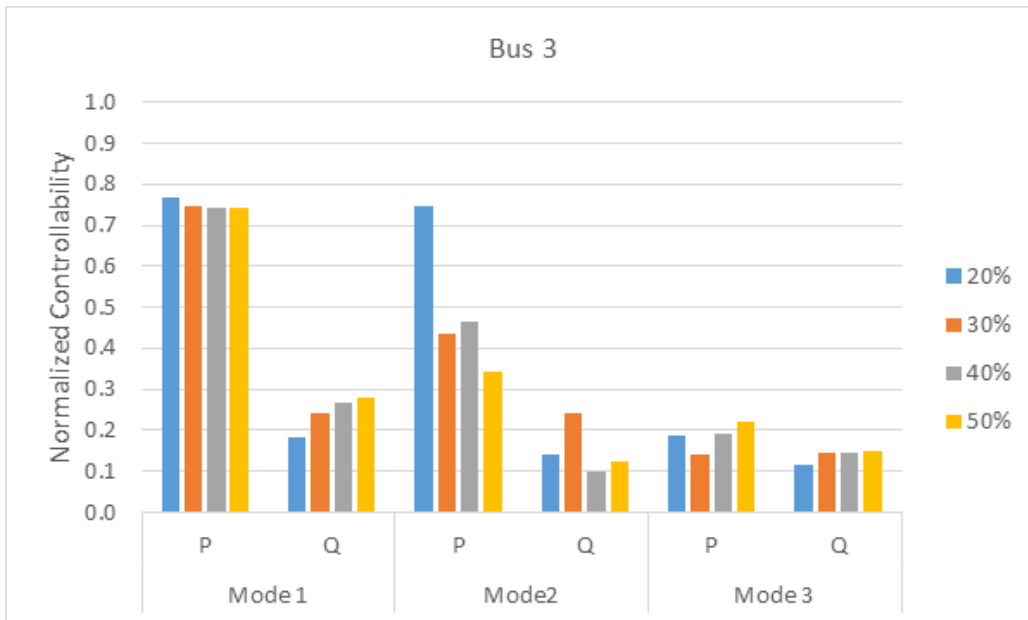

Figure 34: Normalized Controllability indices for active and reactive power injection on Bus 3.

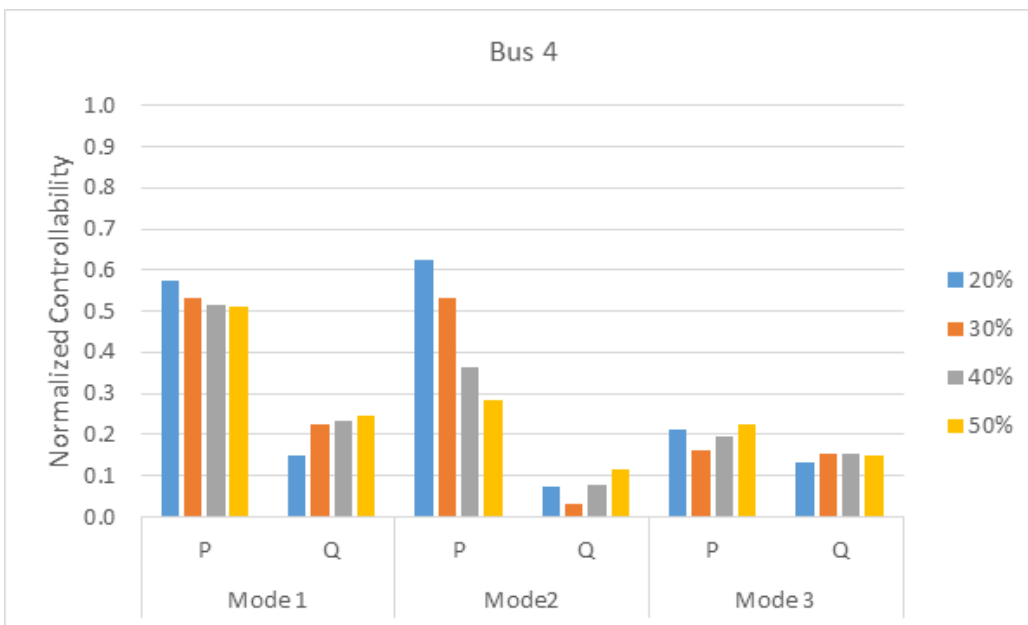

Figure 35: Normalized Controllability indices for active and reactive power injection on Bus 4.

Injection of active or reactive power in a specific bus to damp the power oscillations in the grid is highly dependent on ReGen penetration scenarios. In this case Mode Shape 2 is less controllable in high penetration scenarios. On the other hand Mode 1 can be damped effectively with ReGen in all buses by using active power. Mode 3 in this particular power system seems very difficult to be damped irrespectively of penetration scenarios or the ReGen plants utilized.

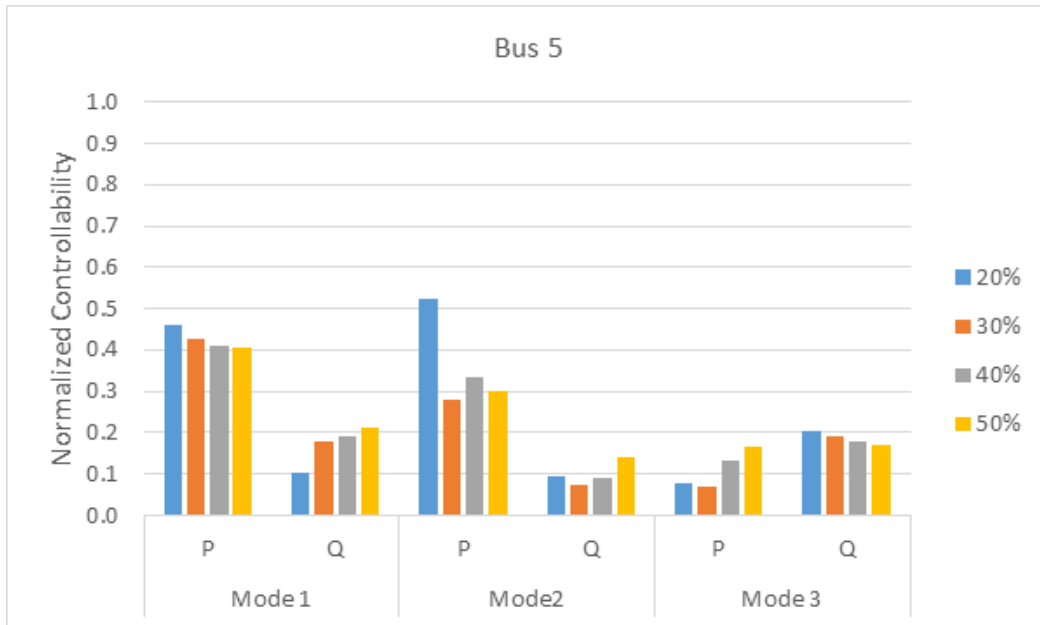

Figure 36: Normalized Controllability indices for active and reactive power injection on Bus 5.

The main conclusions of the work carried out in **WP4** can be summarized as follows:

- RAS support must be considered thoroughly and no general applicable solution exists.
- Power system topology and especially settings in primary control loops in CGUs e.g. prime movers and excitation are having a significant impact on Mode Shapes, thus properties of LFPO. Increased penetration of renewables are also affecting mode shapes
- Observability of Mode Shapes is depending on location of ReGen Plants. Typically, local measurements on PCC may not provide sufficient level of observability of a particular mode shape. Remote measurements may increase observability however, ICT shall be careful considered in these cases
- Active power based controllability of Mode shapes seems to be efficient in most of the studied scenarios while reactive power based one may be limited. Again these results are highly dependent on power system topology, parameters and penetration levels. Studies performed in a different system may reveal other conclusions.
- WP plants may be a feasible provider of this service with both active and reactive power based RAS support. PV plants may provide a reactive power based RAS support as the active power output is highly dependent on solar irradiance in a given location.

Based on the work done in **WP4** the following recommendations have been made:

- Suitability and feasibility of RAS support should fall under TSO attributions. This is the only entity having the sufficient level of information necessary for obtaining meaningful results i.e. actual grid topology, settings on CGUs, expected penetration and location of ReGen including units connected to distribution grids.
- A small signal model of the power grid shall capture the relevant topology both transmission and distribution (aggregated) and shall provide the main mode shapes of interest. Building this model may be challenging for interconnected power grids as the ENTSO-E one. In this case aggregation shall again be considered. The existing models for planning purposes may not contain the relevant information required for RAS investigations i.e. structures and settings for prime movers and excitation systems. Moreover, ReGen plants have to be captured properly as a simple first order response may not be sufficient to capture the control interactions between CGUs and ReGen plants.
- Feasibility studies based on a small signal model of the entire considered system shall include at least eigenvalue analysis, followed by an assessment of normalized indices for participation factors, observability and controllability.
- Tuning of RAS support functionality shall be based on the small signal model
- Time domain assessment of RAS support shall be performed on a dynamic model representing the power grid.



### 1.5.5 Verification of ancillary services from ReGen plants (WP5)

The objective of **WP5** has been to verify the capability of ReGen plants (WP and PV) to provide ancillary services to system operators both on a large scale and a small scale power system. Two different laboratory facilities used for the validation of the control algorithms:

- Real-Time Hardware-in-the-Loop (HIL) environment based on multi-domain physical systems
- SYSLAB facility existing at the DTU Risø Campus

Two deliverable reports [12] and [13] have been generated in **WP5**, corresponding to the two different laboratory facilities, respectively.

#### Validation in Real-Time Hardware-in-the-Loop (HIL) environment

The main goal has been here to achieve validation of coordinated voltage control algorithms proposed in **WP2** [6] and to verify the capability of ReGen plants to provide online voltage control coordination ancillary service to the system operator (i.e. DSO). The approach opted for this validation is novel in that it relies on a Hardware-In-the-Loop (HIL) framework based on hierarchical industrial controller platforms, which are being used nowadays in power plants, and also takes into account the communication networks with relative data traffic.

Based on the set of recordings, [12] presents guidelines and recommendations for practical implementation of the developed control algorithm for voltage control coordination from ReGen plants. The results presented in deliverable [12] provide a deep insight to the stakeholders i.e. wind turbines and PV system manufacturers, system operators regarding the existing boundaries for current technologies and requirements for accommodating the new ancillary services in industrial application.

Initially, the report [12] addresses the validation of the proposed ICT model for offline studies presented in **WP2** [6]. The proposed ICT model is verified and validate through different test cases against the complete network model and related data traffic implemented in the Smart Energy systems laboratory. Based on the results of ICT model validation, it has been concluded in [12] that the performance and characteristics of the offline ICT model are matching the more detailed real-time (RT) HIL model.

Secondly, the validation of coordinated voltage control for ReGen plants in MV grids has been achieved using the Laboratory facilities available at AAU-ET partner, namely the Smart Energy Systems (SES) Laboratory [14]. The structure of this laboratory platform is given in Figure 37. The RT HIL framework used along with the mechanisms for emulating the communication networks and traffic in RT are detailed in [12]. Moreover, a new methodology for designing and verifying controls in power systems has also been proposed. This methodology is termed as "Model-Based Design (MBD) approach".

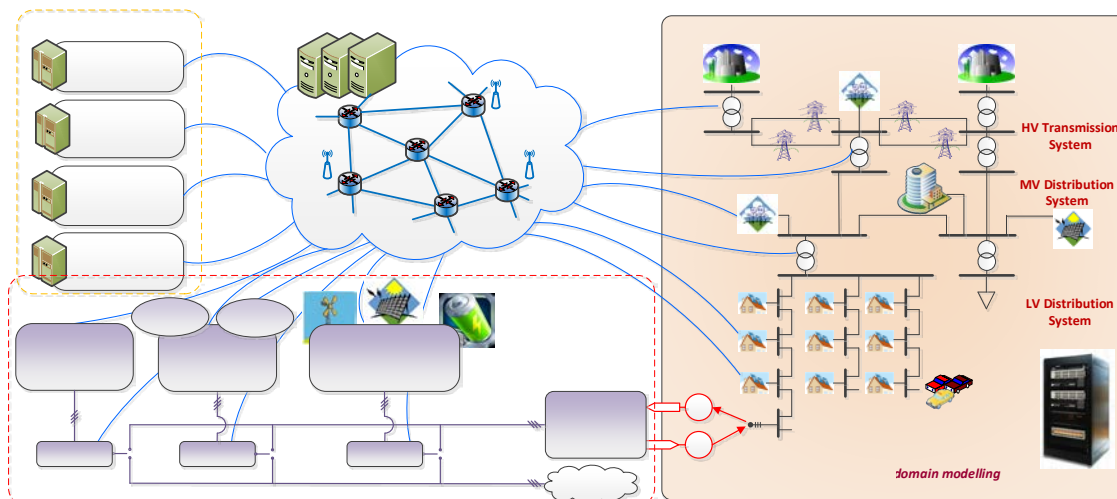

Figure 37: Architecture of Smart Energy Systems Laboratory.

The control architecture for distributed online voltage coordination defined in [6] has been validated. This control architecture requires grid layout and parameters provided by the DSOs, measurements from secondary side of primary substations as well as measurements from each of the controlled ReGen plants. It provides voltage set-points and droop values for each ReGen plant considered in the asset's portfolio. Figure 38 shows the setup used to implement the control architecture for distributed online voltage coordination in the RT HIL framework.

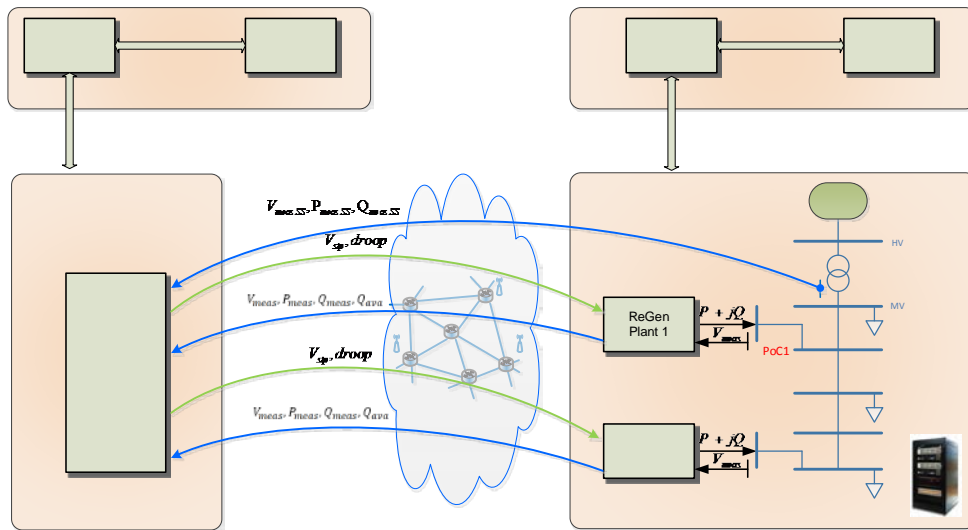

Figure 38: RT-HIL setup used for validation of Distributed On-Line Voltage Coordination.

The report [12] provides details of each component used in the RT HIL setup (shown in Figure 38):

- Aggregator Hardware Platform is based on the industrial controller i.e. M1 controller provided by Bachmann Electronics GmbH [15]. It supports MBD approach using Matlab/Simulink. Further, all the data exchange between Aggregator Hardware and Opal-RT system was executed through the RT ICT Emulator named KauNet [16].
- Benchmark Distribution Grid (BDG) with large penetration of ReGen, used for development of distributed online voltage coordination in **WP2** [6] was implemented in the RT digital simulator. The BDG has been supplemented by one WP plant and three PV plants providing voltage control functionality.
- Grid layout is implemented using ePhasor tool from RTLab [16] and [17].
- WP and solar PV plant models defined in **WP2** [6] have been directly implemented in the Opal-RT System.

Since [12] first addresses the validation of offline communication model and shows that it performs the same as its counterpart i.e. online communication setup (with KauNet network emulator), the selected cases in simulations have been considered for adjusting the voltage set-point of each ReGen plant to evaluate their impact on the power losses within the grid. Thus, the information regarding voltage (V), active power (P) and reactive power (Q) were transmitted using two different update rates as test cases to validate the offline simulations via online setup: i.e.  $T_s = 10$  seconds and  $T_s = 1$  minute. A time-frame of one hour was considered sufficient to represent a volatile power profile covering the extreme operational points at high wind speed and solar irradiation.

Figure 39 shows V, P and Q profile for each ReGen plant in the BDG, both for offline simulation and online/real-time communication setup throughout the considered time frame of 1 hour according to the specified test cases. While Figure 40 shows the percentage error in each case. It can be observed from Figure 40 that in case of V and P from all ReGen plants, collectively the error remained less than 1% approximately. The Ethernet and other real-time effects in the link can be a reason to impose this error. While the relatively higher error initially in each case is expected due to the HIL initialization setup.

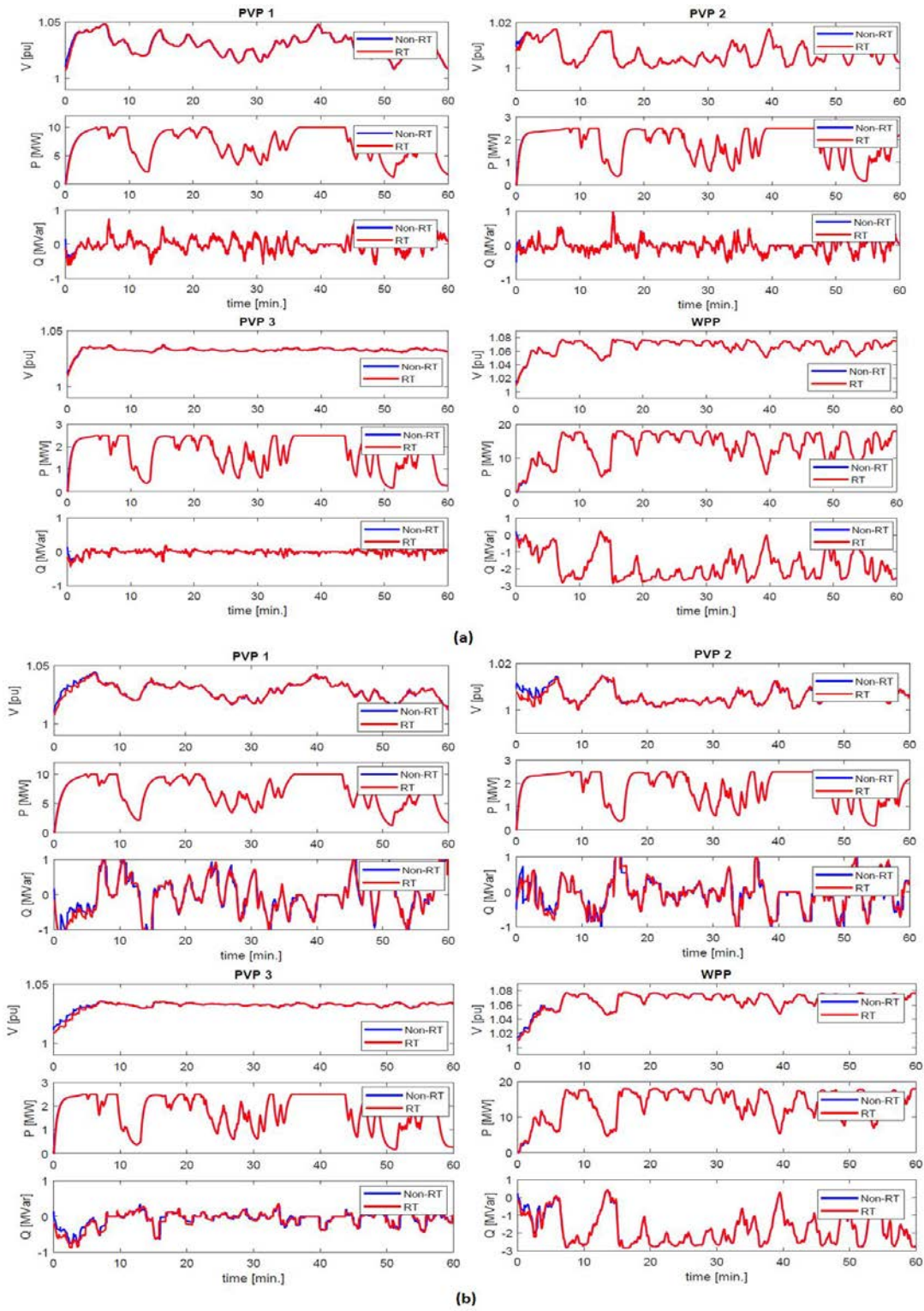
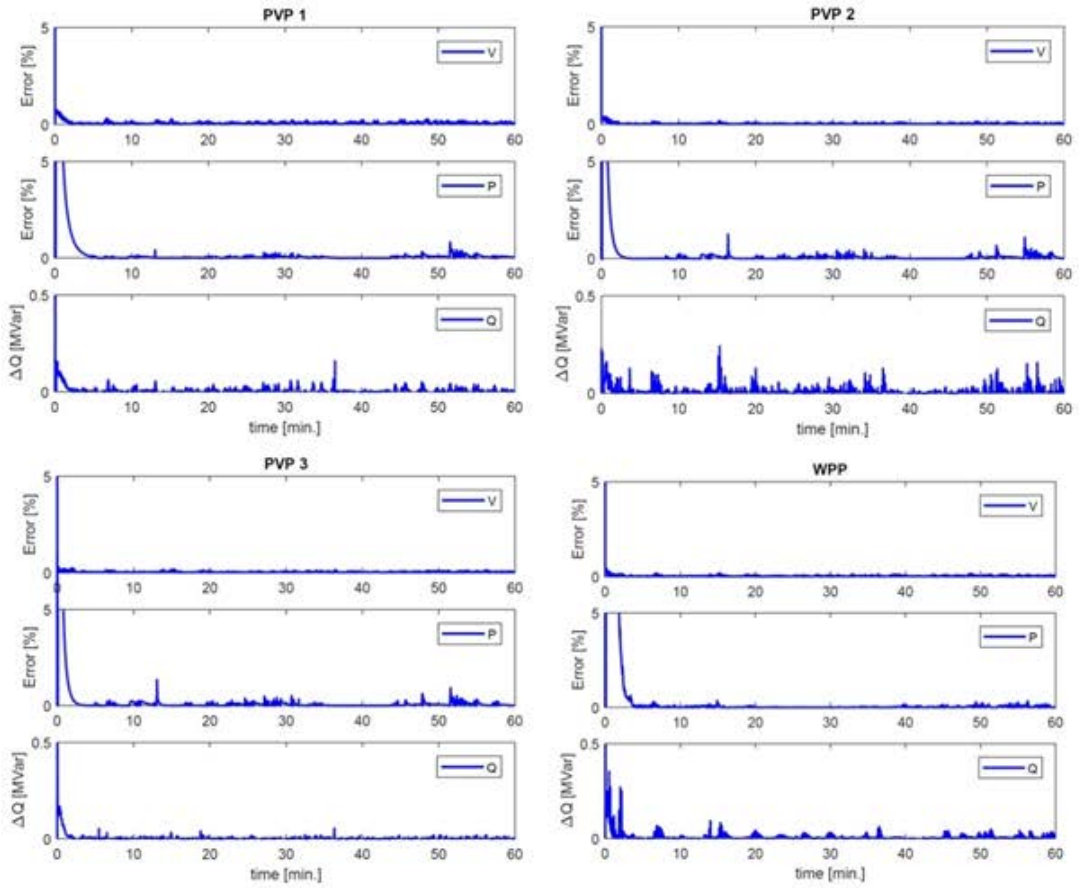

Figure 39: P, Q, V of PV1, PV2, PV3 plants and WP plant over one hour for (a) 10 sec. update rate and (b) 1 minute update rate.

The following assumptions has been made in this stage:

- The distributed online voltage coordination presented and used in **WP2** [1] was used as such.
- The only modifications were related to TCP/IP interfaces between different hardware platforms.
- Since the realized network used for this purpose was a shared public network, the delay varied stochastically. Thus, regarding communication network delay times, following considerations were made:

- **Normal (base) case.** 15 ms delay in the transfer of information update for the maximum times.
  - **Worst case.** In the worst case, the delay may jump up to 500 ms (RTT)
- The various subsystems presented in Figure 38 run with different sampling times in order to capture a realistic behavior of such a system used in real applications. The following considerations were made regarding specific sampling time:
  - **Host PC-Opal RT.** The Monitoring & Control Module is use a sampling time of 200 msec for sending the meteorological data but also for monitoring of the internal variables from Opal-RT System.
  - **Opal-RT System.** The power grid and the ReGen plants run with 10 msec sampling time.
  - The feedback signals from ReGen plants and primary substation to Aggregator Hardware are updated every second.
  - **Aggregator Hardware.** The distributed online voltage coordination algorithm is runs with a sampling time of 500 msec and it sends the set-point values to ReGen plants with the desired update rate.



(a)

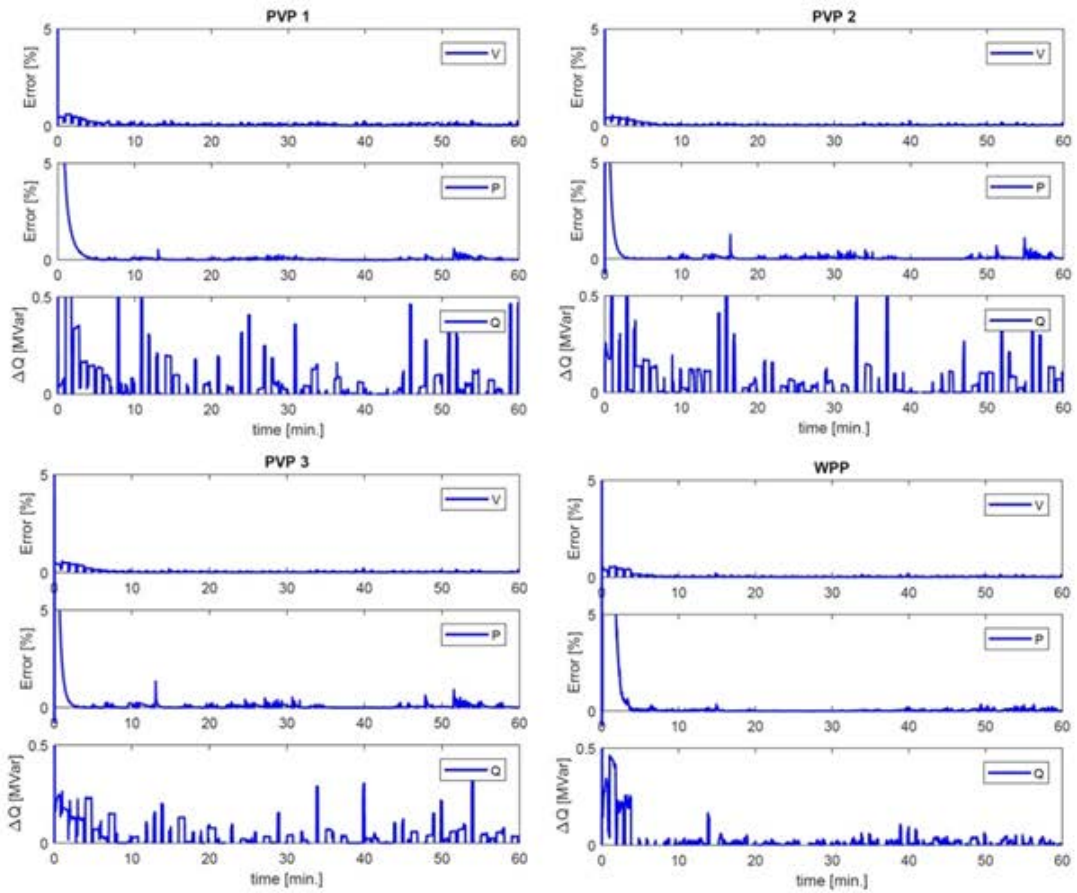

(b)

Figure 40: Error in V, P, Q of PV1, PV2, PV3 plants and WP plant sent via offline and online communication models over one hour for (a) 10 sec. update rate and (b) 1 minute update rate.

The ICT impact on voltage control coordination from Regen plants has been also investigated and validated in the HIL environment.

Extending power system simulation tools for the ICT domain, or vice versa, demands a lot of effort and collaboration among experts of both areas, because the life cycle and technical specifications of the electrical and communication equipment (in terms of reliability requirements, round trip time, determinism, temporal consistency and hierarchy) are significantly different. By creating a so-called co-simulation environment for the integrated analysis of both domains, via ad-hoc connections (or in a master/slave fashion), one can understand the impacts of different communication solutions used for the operation of power systems much better. Although simulation architectures may vary, a co-simulation framework allows in general the joint and simultaneous investigation of models developed with different tools, in which the intermediate results are exchanged during the execution of the simulations. However, the sub-systems are usually solved independently by their corresponding domain-specific simulators. Co-simulation allows to have a complete view of both network behavior and the physical energy system states, while power system and communication networks are simulated with the most suitable solver and the calculation loads are shared.

The simulation based analyses of ICT impact on online voltage control coordination as well as online frequency control have been mainly based on a network simulator developed for offline (non-real-time) simulations. Generally, an offline communication network model is used in the design phase of any control algorithm as well as for verification purposes under a wide range of delays and packet drops. In this way the simulation time for each test case is reduced and a complete view on the impact of ICT for a given control functionality is achieved.

Selected test cases have been validated by using a real-time (RT) communication network model in the real-time Hardware-In-the-Loop (RT-HIL) framework. The main advantage of the RT-HIL approach is that the actual control platform is used with a RT model of the power grid and corresponding assets i.e. ReGen plants and also selected ICT including data traffic. These RT-HIL studies are mainly targeted to get confidence before actual site-test trials, as HIL simulations tend to be less expensive for design changes [17]. Moreover, specific power system phenomena can be replicated in this controlled environment that may not be detected in normal operation of the power grid. Therefore, the performance of offline communication network model has been first validated via RT communication model and then selected cases from the distributed online voltage coordination have been also validated via RT-HIL setup.

Since the HIL based tests for online voltage control coordination in [12] have been performed in Smart Energy System (SES) laboratory (at AAU-ET) [14], its ICT layer mainly comprises of a network emulator, traffic generator, visualization server and a high-speed switch. The network emulator workstation uses KauNet [16] as the network emulator in ICT layer that enables ingoing as well as outgoing data packets to pass a queue configured with a buffer length and service time according to a given stochastic model of a network. Therefore, the offline communication network model has been validated against KauNet network emulator.

Figure 41 captures the original sine wave with the ones received from offline as well as online test setups (with avg. delay = 500 msec.) to show that the results obtained from both test setups are comparable. Overall, from the tests performed for validation, it was concluded that the response of the off-line ICT model is matched the one provided by the RT Network Emulator under the same input and parameters. Secondly, offline model proved to be a powerful but yet simple representations of the communication networks and their traffic especially for off-line multi-run studies focusing on verification of control design. Consequently, selected test cases for online voltage control coordination went to the validation stage in the RT HIL framework.

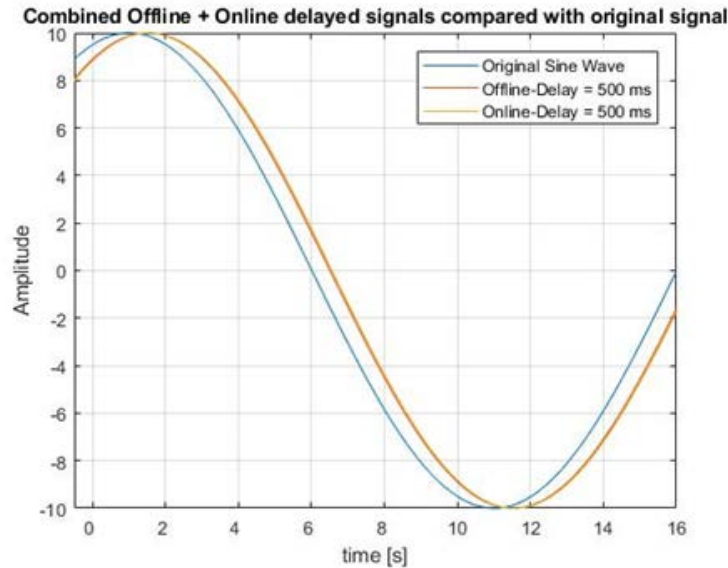

Figure 41: Original sine wave signal compared with delayed signals received from off-line and online test setups.

The main advantage of the RT HIL approach is that the actual control platform is used with a RT model of the power grid and corresponding assets i.e. ReGen plants and also selected ICT including data traffic. These RT HIL studies are mainly targeted to get confidence before actual site test trials. Moreover, specific power system phenomena can be replicated in this controlled environment that may not be detected in normal operation of the power grid.

Based on this work, the offline ICT model is recommended to be used in the design phase of any control algorithm and for verification purposes under a wide range of delays and packet drops. In this way the simulation time for each test case is shortened and a complete view on the impact of ICT for a given control functionality is achieved. The selected test cases have been further validated by using the real-time HIL framework. Therefore, the offline model should be used for preliminary control studies while the detailed real-time HIL model should be used for validation purposes to help achieving high Technology Readiness Level (TRL).

#### Validation in SYSLAB facility existing at the DTU Risø Campus

The main goal has been here to experimentally investigate and underpin the control concept developed to deliver FRR from ReGen power plants. The objective of the control is to ensure the quality of the FRR service is according to the requirements while maximizing the utilisation of the available energy. The concept, described in [10], is how to ensure that the portfolio of ReGen power plants are meeting the power request from the TSO during operation in accordance with the reserve that has been contracted.

The controller has been implemented in the research facility SYSLAB which is part of the PowerLab.dk facilities. The SYSLAB facility is a real distributed facility based on real physical units. The system is depicted in Figure 42. In the figure it is also indicated the two PV plant that are part of the experiment.



Figure 42: SYSLAB research facility with PV plants used for FRR service delivery.

As illustrated in Figure 43, the control setup is a hierarchical system with an aggregator that is situated between the TSO and the ReGen power plants that are coordinated by the aggregator. The aggregator receives the required control signal as a fraction of the total reserve and then distributes this signal to the ReGen Plants. Further, the aggregator forecasts the generation based on input from the ReGen plants and determines the optimal base set point of the individual ReGen plants to ensure the delivery of the service while minimizing the potential production. As described in [13] this is based on a statistical approach on the the forecasts as well as on the regulation requirements. The quality of the service is measured as a percentage of power over time that the service is not delivered and it should be less than e.g. 1%

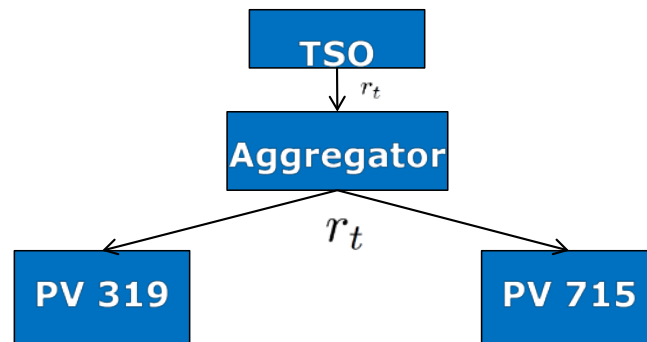

$$P_{ref,t}^i = P_{sch}^i + r_t P_{res}^i$$

Figure 43: Controller setup for tests in SYSLAB.

An example of a test is depicted in Figure 44. It can be observed that for the majority of the time the system is able to deliver the expected service. There are two instances where the expected output and expected control signal made it impossible to track the reference. The controller is also monitoring this and calculating the error in delivery of the service as seen in the lower part of the figure. Since the error is higher than allowed the controller will in the next timeframe be more conservative i.e. lower the base line set point and by this improve the quality of service for that timeframe.

From the experiments it can be concluded that the proposed method that give promising results in simulations can also be implemented in real hardware. The work has shown that:

- the forecast of the production is essential for the method
- the forecast becomes more complicated when the output is being manipulated due to lack of real reference of the potential
- even for hardware that has not been developed to supply this type of service the approach can be done with relatively good performance
- it is important that the system operators agree on this type of service delivery



- o that the base for calculating the reserve is updated with short intervals e.g. 5-10min
- o that a statistical measure is introduced to allow improved profitability by increasing the utilisation of the potential RE production

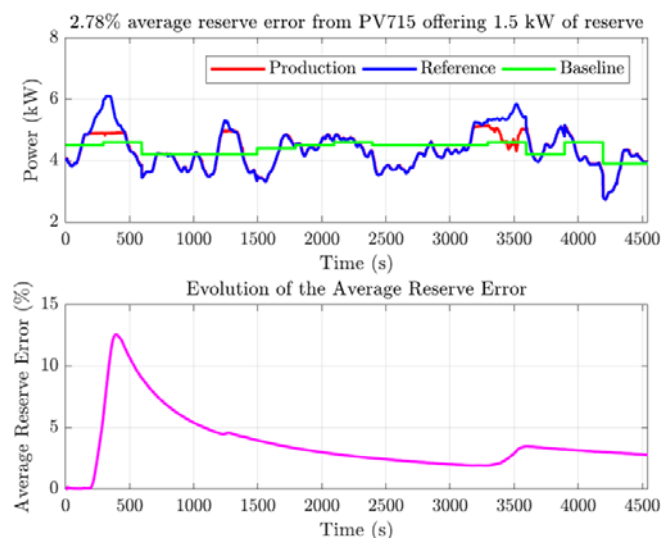

Figure 44: Test results from 04 Dec 2018.

## 1.6 Utilization of project results

### Commercial viability

RePlan project has defined a set of guidelines and recommendations for practical implementation of control algorithms for WP and PV ancillary services, which aimed to provide technical and academic knowledge and a deep insight for stakeholders i.e. wind turbines and PV system manufacturers, system operators regarding the existing boundaries for current technologies and requirements for accommodating the new ancillary services in industrial application.

Commercial exploitation of RePlan results is highly dependent on existing regulatory framework and existing markets. However, these guidelines and recommendations may be utilized to shape the future offerings of ReGen plants integrated in new ancillary service markets.

From Vestas point of view, the results of the project are expected to be used for further developing of Vestas Power Plant controller functionalities, and better understanding of the impact on the grid from different operations on WP and PV plants. The project results export relevant knowledges for power plant control aspect, but no increased turnover and employment so far. The results have not been incorporated in any Vestas products yet. However, eventhough the timeline is uncertain, the project partners, inclusive Vestas expect that the RePlan project results in increased turnover, exports and employment in the future.

The RePlan results and studies might be taken into consideration and used for further developing of the Vestas Power Plant Controller which should control both WP and PV plants.

From Vestas point of view, operating renewable energy generation units for frequency control or voltage control purpose is an essential research area, as one of the main energy industry potentials.

### Technical viability

RePlan has thoroughly developed, described, tested and verified the control functionality of different ancillary services from WP and PV, which are in a state that they could be adopted across manufacturers and TSOs. There is, though, still room for improvements.

**WP1** reported a generic hierarchical control framework for the renewable generation (ReGen) plants control functions, control architecture (levels, concepts, coordination) as well as on the

model for aggregated WP and PV plants and the power system, including communication properties. A very good overview of a general system architecture including the power system structure and its assets, the communication layer and the involved actors having roles and responsibilities for ancillary services (ICT actors, market players, technical performance players) is provided.

**WP2, WP3 and WP4** reported on the three ancillary services from WP and PV plants: voltage, frequency and rotor angular stability support. The needs for these ancillary services from ReGen plants have been quantified through several studies, taking the size, the robustness of power system, as well as the technical characteristics and the penetration levels of the ReGen into consideration. The incorporation of ICT communication properties and of power availability has been considered in the development and implementation of the controllers for the delivery of ancillary services. Representative simulation models for WP and PV plants and their control have been then identified and further developed to assess their behaviour and the suitability to coordinate their support to the power system for the identified test cases.

Guidelines and recommendations for implementation of control algorithms for WP and PV ancillary services have been generated. This is believed to be the first ever reported methods, models and investigations of ReGen plant coordination in their provision of ancillary services. The models and simulation models are readily adoptable for other network studies.

**WP5** reported the verification of the capability of ReGen plants to provide voltage and frequency control, ancillary services to system operators both on a large scale and a small scale power system. The experiments have shown that the developed control algorithms that give promising results in simulations can also be implemented in real hardware.

Furthermore, **WP2, WP3, WP5** and their derived publications have provided, to the best knowledge, the very first investigations to explore the impact of the ICT infrastructure on voltage control and frequency control services, services coordination between ReGen plants as well as the role of ICT in the validation of these ancillary services via Hardware-in-the-Loop (HIL) framework. It has been shown that in order to have online voltage/frequency stability support from ReGen plants to ensure the system stability, these plants should have a resilient online coordination with the system operator (i.e. DSO/TSO), which however, depends on the requirements imposed on the ICT infrastructure.

### **Intellectual Property Rights**

No patent application has been filled during the project period.

### **Future work**

It is clear that there is potential to coordinate WP and PV plants to provide ancillary services, but future studies need to be carried out, especially regarding more detailed insight on the impact of ICT on the coordination and activation of ReGen plants for provision of ancillary services. Further technical development is also needed regarding development of more accurate environmental models and forecasting tools for better estimation of the ReGen plants output.

The market and economical regulatory aspects have not been in the scope of RePlan project, the focus being mainly kept on technical issues in power systems. Whoever becomes first mover, any ReGen ancillary services market inclusion requires a convincing financial case, routed via the authorities to a proposal for the actual rules for market participation. Together with synthesis of the technical conditions of network in question (energy flow, power balance, system stability), the associated financial value must be synthesised.

### **Dissemination**

The RePlan project has been widely published and presented throughout the project period. The tables below list the scientific papers published and the contributions made at symposia and conferences. The exposure is almost exclusively on the technical findings of the project.

WP1	<b>Provision of enhanced ancillary services from wind power plants – examples and challenges</b> A.D. Hansen, M. Altin, F. Iov Renewable Energy Journal , nr. 97, 2016, pp. 8-18
WP1	<b>Ancillary services from Renewable Power Plants - RePlan Project</b> M. Altin, A.D. Hansen, N.A. Cutululis, H.W. Bindner, F. Iov Proceedings of the 14th Wind Integration Workshop, Brussels, 2015
WP1	<b>Wind Power Plant Control Optimisation with incorporation of wind turbines and STATCOMs</b> L. Petersen, F. Kryezi, F. Iov, L. H. Kocewiak Proceedings of the 14th Wind Integration Workshop, Brussels, 2015
WP2	<b>Voltage Control Support and Coordination between Renewable Generation Plants in MV Distribution Systems</b> L. Petersen, F. Iov, A.D. Hansen, M. Altin Proceedings of 15th Wind Integration Workshop, Belgium, 2016
WP2	<b>Practical Considerations regarding Implementation of Wind Power Applications into Real-Time Hardware-In-The-Loop Framework</b> L. Petersen, F. Iov NEIS Conference 2016: Sustainable Energy Supply and Energy Storage Systems, Hamburg, Germany
WP2	<b>Distributed voltage control coordination between renewable generation plants in MV distribution grids</b> L. Petersen, F. Iov 24th International Conference Electricity Distribution (CIRED), Glasgow, UK, 2017
WP2	<b>Wind Power Plant Control Optimisation with Embedded Application of Wind Turbines and STATCOMs</b> L. Petersen, F. Kryezi, F. Iov IET Renewable Power Generation, 2016
WP2	<b>On the Impact of using Public Network Communication Infrastructure for Voltage Control Coordination in Smart Grid Scenario.</b> K. Shahid, L. Petersen, R. L. Olsen, F. Iov EAI International Conference on Smart Grid Inspired Future Technologies (SMARTGIFT 2017), London, UK, 2017
WP2	<b>Information Reliability in Smart Grid Scenario over Imperfect Communication Networks using IEC-61850 MMS</b> R. Umair, K. Shahid, R. L. Olsen 17 <sup>th</sup> IEEE International Conference on Smart Technologies (IEEE EUROCON 2017), Ohrid, Macedonia, 2017
WP2	<b>Impact of Transport Layer Protocols on Reliable Information Access in Smart Grids</b> K. Shahid, L. Petersen, R. L. Olsen, F. Iov 7 <sup>th</sup> IEEE International Conference on Innovative Smart Grid Technologies (ISGT Europe 2017), Turin, Italy, 2017
WP2	<b>On the Impact of Cyberattacks on Voltage Control Coordination by ReGen Plants in Smart Grids,</b> K. Shahid, L. Petersen, R. L. Olsen, F. Iov 8 <sup>th</sup> IEEE International Conference on Smart Grid Communications (SmartGridComm 2017), Germany, 2017
WP3	<b>Optimization of inertial response from WPPs in power systems with high wind power penetration</b> J.C. Kuhlmann; M. Altin , A.D. Hansen Proceedings of 16th Wind Integration Workshop, 2017
WP3	<b>Analysis of Wind Turbine Loading during Short-term Overproduction</b> M. Altin, A. Barlas, A. D. Hansen WESC Lyngby 2017
WP3	<b>A Statistical Method for Aggregated Wind Power Plants to Provide Secondary Frequency Control</b> H. Junjie, Z. Charalampos, H.W. Bindner, H. Xue Proceedings of 16th Wind Integration Workshop, 2017
WP2	<b>ICT Requirements and Challenges for Provision of Grid Services from Renewable Generation Plants</b> K. Shahid, L. Petersen, R. L. Olsen, F. Iov 2018 International Conference on Smart Grid and Clean Energy Technologies (ICSGCE 2018), Kuala Lumpur, Malaysia
WP3	<b>Optimization of Synthetic Inertial Response from Wind Power Plants</b> M. Altin, J. C. Kuhlmann, K. Das, A. D. Hansen Energies 2018. 11, no.5:1051, DOI: 10.3390/en11051051.
WP3	<b>Analysis of Inertial Response from Wind Turbines</b> J. C. Kuhlmann, M. Altin, A. D. Hansen WESC Lyngby 2017
WP3	<b>ICT based Performance Evaluation of Primary Frequency Control Support and Coordination from ReGen Plants in Smart Grids</b> K. Shahid, M. Altin, L. M. Mikkelsen, R. L. Olsen, F. Iov Energies 2018, 11(6), 1329, Online Available <a href="http://www.mdpi.com/1996-1073/11/6/1329">http://www.mdpi.com/1996-1073/11/6/1329</a>
WP3	<b>Optimization of Short-term Overproduction Response of Variable Speed Wind Turbines</b> M. Altin, A. D. Hansen, Thanasis K. Barlas, K. Das, and J. N. Sakamuri IEEE Transactions on Sustainable Energy, (in a future issue) DOI: 10.1109/TSTE.2018.2810898
WP5	<b>ICT Based HIL Validation of Voltage Control Coordination in Smart Grids Scenarios</b> K. Shahid, L. Petersen, R. L. Olsen, F. Iov Energies 2018, 11(6), 1327, Online Available: <a href="http://www.mdpi.com/1996-1073/11/6/1327">http://www.mdpi.com/1996-1073/11/6/1327</a>

Table 8: Conference and journal publications.

14th Wind Integration Workshop, Brussels, 2015
NEIS Conference 2016: Sustainable Energy Supply and Energy Storage Systems, Hamburg, Germany
15th Wind Integration Workshop, Belgium, 2016
Opal User Workshop, June 2016, Munich, Germany
6 <sup>th</sup> Solar Integration Workshop, 2016 Vienna, Austria
16th Wind Integration Workshop, Berlin, 2017
Full day RePlan workshop on 26 <sup>th</sup> September 2016 with Energinet.dk on Smart Energy Systems laboratory
8th IEEE International Conference on Smart Grid Communications (SmartGridComm 2017), Germany, 2017
Opal-RT workshop in March 2017
Power and Energy Engineering Conference, October 2017, London, UK
24th International Conference Electricity Distribution (CIRED), Glasgow, UK, 2017
EAI International Conference on Smart Grid Inspired Future Technologies (SMARTGIFT 2017), London, UK, 2017
7 <sup>th</sup> IEEE International Conference on Innovative Smart Grid Technologies (ISGT Europe 2017), Turin, Italy, 2017
EAI International Conference on Smart Grid Inspired Future Technologies (SMARTGIFT 2017), London, UK, 2017
Wind Energy Science Conference Lyngby 2017
17th IEEE International Conference on Smart Technologies (IEEE EUROCON 2017), Ohrid, Macedonia.
International Conference on Smart Grid and Clean Energy Technologies (ICSGCE 2018), Kuala Lumpur, Malaysia
Full day RePlan workshop on 6th December 2017, DTU Wind Energy- Risø Campus Roskilde

*Table 9: Conference/symposium contributions, invited presentations.*

Project progress and results were also presented in bi-lateral workshops with relevant actors i.e. September 2016 with Energinet.dk and June 2017 and October 2017 with Vattenfall.

### **1.7 Project conclusion and perspective**

RePlan has met successfully its initial objectives by showing that renewable generation (ReGen) plants, like wind power (WP) and photovoltaic (PV) plants are able to provide ancillary services (i.e. voltage, frequency and rotor angular stability support), which are needed to ensure the system stability comprising both the transmission and distribution levels.

RePlan has identified, described, characterised and demonstrated how different WP and PV plants can provide ancillary services. The technical ambitions were largely met. The novelty of the RePlan approach relies on considering the hierarchical industrial controller platforms used nowadays in power plants. Moreover, the communication networks as well as their data traffic have been taken into account.

Based on detailed investigations, a set of guidelines and recommendations for practical implementation of the developed control algorithms for targeted ancillary services have been defined. This is providing a deep technical insight for stakeholders i.e. wind turbines and PV system manufacturers, system operators regarding the existing boundaries for current technologies, the impact of the Information and Communication Technologies (ICT) infrastructure on provision of ancillary services and coordination from Regen plants as well as the requirements for accommodating new ancillary services in industrial application. The role and the impact of ICT on the provision of the considered ancillary services have been investigated.

The project has moved the ReGen plants technical capability forward and has widely communicated its technical results to relevant stakeholders.

For example, the RePlan project has proposed control and coordination architectures for voltage control in distribution grids that accounts for ICT but also has devised roles and responsibilities of various actors. In this respect, Replan project has generated a set of recommendations to the national Danish grid codes (i.e. regarding the extension of the reactive power capability of PV plants at full active power production), to the DSOs (i.e. regarding the evaluation of the voltage fluctuations and grid power losses due to renewable power generation infeed), as well as to the aggregators of grid support services (i.e. regarding the parametrization of voltage control functions in ReGen plants and the placement of the central aggregator control unit).

Furthermore, a fast frequency response (FFR) optimization approach has been developed in the transmission level in order to coordinate the FFR of WP plants and thereby improve the power system characteristics.

The consideration of ICT in the development of a coordination scheme for FFR has resulted in delivery of a set of recommendations for the design and tuning methodology as well as for coordination and activation of ReGen plants in provision of frequency control, since these actions must account for the delays in ICT – especially when using public networks. Regarding frequency restoration reserve (FRR), a statistical online decision making system has been proposed in RePlan project. This improves the economics of ReGen plants meanwhile respecting the frequency service performance requirement, that can optimally allocate base power setting to ReGen power plants. Regarding rotor angular stability (RAS) a systematic assessment of low frequency power oscillations (LFPO) in power grids with large penetration of renewable generation has been performed considering the ICT impact on RAS support and delivering a set of recommendations to the TSOs like i.e. suitability and feasibility of RAS support should fall under TSO attributions and to grid codes, i.e. no firm requirement regarding RAS shall be included in grid codes.

The verification of some ancillary services has been performed, where possible, being tested in a Real-Time Hardware-in-the-Loop (HIL) environment based on multi-domain physical systems or in a real small scale power system, namely the SYSLAB facility existing at the DTU Risø Campus. For example the validation of coordinated voltage control algorithm for ReGen plants in MV grids incorporating the ICT and communication data traffic has been achieved in the Real-Time HIL framework. The impact of the ICT infrastructure on the considered ancillary services as well as the role of ICT in the validation of these ancillary services via the Real-Time HIL framework have been investigated as well. The experimental setup at the DTU Risø Campus has been used to validate operations under realistic conditions, i.e. whether ReGen plants can provide fast frequency control, assess the control capabilities of the plants and the accuracy in reserve provision. It was found that it is possible to offer fast frequency reserves using small PV units and that the communication delays and the dynamics of the units allow PV units equipped with controllable inverters to provide frequency reserves with extremely good accuracy, provided that there is enough available production.

Looking ahead, there is potential to coordinate WP and PV plants to provide ancillary services, but future studies need to be carried out, especially regarding more detailed insight on the impact of ICT on the coordination and activation of ReGen plants for provision of ancillary services. The results of this work can be used as a solid starting base in the design of future hybrid ReGen power plants and investigation of the interaction and coordination between ReGen plants' individual internal assets, i.e. WP and PV units. Further technical development is also needed regarding development of more accurate environmental models and forecasting tools for better estimation of the ReGen plants output. In addition, further validation of the impact of ICT infrastructure and its role on the ancillary services provision and coordination from ReGen plants can be of high relevance for future work. However, before further technical development is undertaken, the market preparation should be analysed in detail, including taking concrete steps towards payment for ancillary services from WP and PV as an important mean to increase renewable's role in the energy mix.

## References

- [1] RePlan project application 2015
- [2] RePlan D1.1 deliverable:  
*Specifications for ReGen plant model and control architecture*, 2015
- [3] RePlan D1.2 deliverable:  
*Technical Feasibility of Ancillary Services provided by ReGen plants*, 2015.
- [4] RePlan D1.3 deliverable:  
*A review on Optimal dispatch methods for ReGen Plants*, 2015
- [5] Replan additional report:  
*Communication aspects in Replan*, 2016
- [6] RePlan D2 deliverable:  
*Voltage control support and coordination between ReGen plants in distribution systems*, 2016.
- [7] Lennart Petersen; Florin Iov; Anca D. Hansen; Mufit Altin;  
*Voltage Control Support and Coordination between Renewable Generation Plants in MV Distribution Systems*. Vienna: 15th Wind Integration Workshop, 2016.
- [8] Lennart Petersen; Florin Iov;  
*Distributed Voltage Control Coordination between Renewable Generation Plants in MV Distribution Grids*. Glasgow: 24<sup>th</sup> International Conference on Electricity Distribution, 2017
- [9] RePlan D4 deliverable:  
*Rotor angle stability support from ReGen plants in power systems*, February 2018
- [10] RePlan D3 deliverable:  
*Frequency stability control support from ReGen plants*, 2017.
- [11] Kaushik Das,  
*Integration of Renewable Generation in Power System Defence Plans*, PhD Thesis, 2016.
- [12] RePlan D5.1 deliverable:  
*Verification of Ancillary services in Large Scale Power System*, 2018
- [13] RePlan D5.2 deliverable:  
*Experimental Validation of Fast Frequency Control from ReGen plants*, 2018
- [14] Smart Energy Systems Laboratory, 2018. [Online]. Available:  
<http://www.et.aau.dk/laboratories/power-systems-laboratories/smart-energy-systems/>
- [15] Bachmann, Bachmann Electronics - System Overview, Bachmann, 2018. [Online]. Available:  
<https://www.bachmann.info/en/service/download-area/catalog-system-overview/>
- [16] J. Garcia, E. Conchon, T. Pérennou and A. Brunstrom,  
*KauNet: Improving Reproducibility for Wireless and Mobile Research*, 2007.
- [17] ePHASORSIM - OPAL-RT Technologies, 2018. [Online]. Available: <https://www.opal-rt.com/systems-ephasorsim/>